

SIEMENS

SINAMICS V90, SIMOTICS S-1FL6

PROFINET (PN) interface

Getting Started

Compact Operating Instructions

Table of contents

1	Fundamental safety instructions	3
1.1	General safety instructions	3
1.2	Equipment damage due to electric fields or electrostatic discharge	7
1.3	Warranty and liability for application examples	7
1.4	Industrial security	7
1.5	Residual risks of power drive systems	8
2	General information	9
2.1	Deliverables	9
2.1.1	Drive components	9
2.1.2	Motor components	14
2.2	Device combination	17
2.3	Accessories	20
2.4	Function list	22
2.5	Technical data	22
2.5.1	Technical data - servo drives	22
2.5.2	Technical data - servo motors	25
2.5.3	Address of CE-authorized manufacturer	28
3	Mounting	29
3.1	Mounting the drive	29
3.2	Mounting the motor	34
4	Connecting	41
4.1	System connection	41
4.2	Main circuit wiring	46
4.2.1	Line supply - L1, L2, L3	46
4.2.2	Motor power - U, V, W	48
4.3	Control/Status interface - X8	49
4.3.1	Interface definition	49
4.3.2	Standard wiring	50
4.4	24 V power supply/STO	51
4.5	Encoder interface - X9	53
4.6	External braking resistor - DCP, R1	56
4.7	Motor holding brake	56
4.8	PROFINET interface - X150	57
5	Commissioning	58
5.1	Introduction to the BOP	59
5.2	Initial commissioning in JOG mode	64

5.3	Commissioning in basic positioner control mode (EPOS).....	66
5.4	Commissioning in speed control mode (S).....	67
5.5	Commissioning control functions.....	68
5.5.1	Speed limit.....	68
5.5.2	Torque limit.....	69
5.5.3	EJOG.....	70
6	PROFINET communication.....	70
6.1	Supported telegrams.....	71
6.2	I/O data signals.....	72
6.3	Control word definition.....	74
6.3.1	STW1 control word (for telegrams 1, 2, 3, 5).....	74
6.3.2	STW2 control word (for telegrams 2, 3, 5).....	74
6.3.3	STW1 control word (for telegrams 102, 105).....	75
6.3.4	STW2 control word (for telegrams 102, 105).....	76
6.3.5	STW1 control word (for telegrams 7, 9, 110, 111).....	76
6.3.6	STW2 control word (for telegrams 9, 110, 111).....	77
6.3.7	G1_STW encoder 1 control word.....	77
6.3.8	SATZANW control word.....	78
6.3.9	MDI_MOD control word.....	79
6.3.10	POS_STW control word.....	79
6.3.11	POS_STW1 positioning control word.....	80
6.3.12	POS_STW2 positioning control word.....	80
6.4	Status word definition.....	81
6.4.1	ZSW1 status word (for telegrams 1, 2, 3, 5).....	81
6.4.2	ZSW2 status word (for telegrams 2, 3, 5).....	81
6.4.3	ZSW1 status word (for telegrams 102, 105).....	81
6.4.4	ZSW2 status word (for telegrams 102, 105).....	82
6.4.5	ZSW1 status word (for telegrams 7, 9, 110, 111).....	82
6.4.6	ZSW2 status word (for telegrams 9, 110, 111).....	83
6.4.7	G1_ZSW encoder 1 status word.....	83
6.4.8	MELDW status word.....	84
6.4.9	POS_ZSW1 positioning status word.....	84
6.4.10	POS_ZSW2 positioning status word.....	84
7	Parameters.....	85
7.1	Overview.....	85
7.2	Parameter list.....	86
8	Diagnostics.....	117
8.1	Overview.....	117
8.2	List of faults and alarms.....	119

1 Fundamental safety instructions

1.1 General safety instructions



⚠ WARNING

Electric shock and danger to life due to other energy sources

Touching live components can result in death or severe injury.

- Only work on electrical devices when you are qualified for this job.
- Always observe the country-specific safety rules.

Generally, the following six steps apply when establishing safety:

1. Prepare for disconnection. Notify all those who will be affected by the procedure.
2. Isolate the drive system from the power supply and take measures to prevent it being switched back on again.
3. Wait until the discharge time specified on the warning labels has elapsed.
4. Check that there is no voltage between any of the power connections, and between any of the power connections and the protective conductor connection.
5. Check whether the existing auxiliary supply circuits are de-energized.
6. Ensure that the motors cannot move.
7. Identify all other dangerous energy sources, e.g. compressed air, hydraulic systems, or water. Switch the energy sources to a safe state.
8. Check that the correct drive system is completely locked.

After you have completed the work, restore the operational readiness in the inverse sequence.



⚠ WARNING

Risk of electric shock and fire from supply networks with an excessively high impedance

Excessively low short-circuit currents can lead to the protective devices not tripping or tripping too late, and thus causing electric shock or a fire.

- In the case of a conductor-conductor or conductor-ground short-circuit, ensure that the short-circuit current at the point where the inverter is connected to the line supply at least meets the minimum requirements for the response of the protective device used.
- You must use an additional residual-current device (RCD) if a conductor-ground short circuit does not reach the short-circuit current required for the protective device to respond. The required short-circuit current can be too low, especially for TT supply systems.



⚠ WARNING

Risk of electric shock and fire from supply networks with an excessively low impedance

Excessively high short-circuit currents can lead to the protective devices not being able to interrupt these short-circuit currents and being destroyed, and thus causing electric shock or a fire.

- Ensure that the prospective short-circuit current at the line terminal of the inverter does not exceed the breaking capacity (SCCR or I_{cc}) of the protective device used.



⚠ WARNING

Electric shock if there is no ground connection

For missing or incorrectly implemented protective conductor connection for devices with protection class I, high voltages can be present at open, exposed parts, which when touched, can result in death or severe injury.

- Ground the device in compliance with the applicable regulations.



⚠ WARNING

Electric shock due to connection to an unsuitable power supply

When equipment is connected to an unsuitable power supply, exposed components may carry a hazardous voltage that might result in serious injury or death.

- Only use power supplies that provide SELV (Safety Extra Low Voltage) or PELV- (Protective Extra Low Voltage) output voltages for all connections and terminals of the electronics modules.



! WARNING

Electric shock due to damaged motors or devices
 Improper handling of motors or devices can damage them.
 Hazardous voltages can be present at the enclosure or at exposed components on damaged motors or devices.

- Ensure compliance with the limit values specified in the technical data during transport, storage and operation.
- Do not use any damaged motors or devices.



! WARNING

Electric shock due to unconnected cable shields
 Hazardous touch voltages can occur through capacitive cross-coupling due to unconnected cable shields.

- As a minimum, connect cable shields and the cores of cables that are not used at one end at the grounded housing potential.



! WARNING

Arcing when a plug connection is opened during operation
 Opening a plug connection when a system is operation can result in arcing that may cause serious injury or death.

- Only open plug connections when the equipment is in a voltage-free state, unless it has been explicitly stated that they can be opened in operation.



! WARNING

Electric shock due to residual charges in power components
 Because of the capacitors, a hazardous voltage is present for up to 5 minutes after the power supply has been switched off. Contact with live parts can result in death or serious injury.

- Wait for 5 minutes before you check that the unit really is in a no-voltage condition and start work.

NOTICE

Property damage due to loose power connections

Insufficient tightening torques or vibration can result in loose power connections. This can result in damage due to fire, device defects or malfunctions.

- Tighten all power connections to the prescribed torque.
- Check all power connections at regular intervals, particularly after equipment has been transported.

! WARNING

Spread of fire from built-in devices

In the event of fire outbreak, the enclosures of built-in devices cannot prevent the escape of fire and smoke. This can result in serious personal injury or property damage.

- Install built-in units in a suitable metal cabinet in such a way that personnel are protected against fire and smoke, or take other appropriate measures to protect personnel.
- Ensure that smoke can only escape via controlled and monitored paths.

! WARNING

Active implant malfunctions due to electromagnetic fields

Inverters generate electromagnetic fields (EMF) in operation. People with active implants in the immediate vicinity of this equipment are at particular risk.

- As the operator of an EMF-emitting installation, assess the individual risks of persons with active implants. The following clearances are usually adequate:
 - No clearance to closed control cabinets and shielded MOTION-CONNECT supply cables
 - Forearm length (approx. 35 cm clearance) to distributed drive systems and open control cabinets

 **WARNING**

Active implant malfunctions due to permanent-magnet fields

Even when switched off, electric motors with permanent magnets represent a potential risk for persons with heart pacemakers or implants if they are close to converters/motors.

- If you have a heart pacemaker or implant, maintain a minimum distance of 2 m.
- When transporting or storing permanent-magnet motors always use the original packing materials with the warning labels attached.
- Clearly mark the storage locations with the appropriate warning labels.
- IATA regulations must be observed when transported by air.

 **WARNING**

Unexpected movement of machines caused by radio devices or mobile phones

When radio devices or mobile phones with a transmission power > 1 W are used in the immediate vicinity of components, they may cause the equipment to malfunction. Malfunctions may impair the functional safety of machines and can therefore put people in danger or lead to property damage.

- If you come closer than around 2 m to such components, switch off any radios or mobile phones.
- Use the "SIEMENS Industry Online Support app" only on equipment that has already been switched off.

NOTICE

Damage to motor insulation due to excessive voltages

When operated on systems with grounded line conductor or in the event of a ground fault in the IT system, the motor insulation can be damaged by the higher voltage to ground. If you use motors that have insulation that is not designed for operation with grounded line conductors, you must perform the following measures:

- IT system: Use a ground fault monitor and eliminate the fault as quickly as possible.
- TN or TT systems with grounded line conductor: Use an isolating transformer on the line side.

 **WARNING**

Fire due to inadequate ventilation clearances

Inadequate ventilation clearances can cause overheating of components with subsequent fire and smoke. This can cause severe injury or even death. This can also result in increased downtime and reduced service lives for devices/systems.

- Ensure compliance with the specified minimum clearance as ventilation clearance for the respective component.

 **WARNING**

Unrecognized dangers due to missing or illegible warning labels

Dangers might not be recognized if warning labels are missing or illegible. Unrecognized dangers may cause accidents resulting in serious injury or death.

- Check that the warning labels are complete based on the documentation.
- Attach any missing warning labels to the components, where necessary in the national language.
- Replace illegible warning labels.

NOTICE

Device damage caused by incorrect voltage/insulation tests

Incorrect voltage/insulation tests can damage the device.

- Before carrying out a voltage/insulation check of the system/machine, disconnect the devices as all converters and motors have been subject to a high voltage test by the manufacturer, and therefore it is not necessary to perform an additional test within the system/machine.

 **WARNING**

Unexpected movement of machines caused by inactive safety functions

Inactive or non-adapted safety functions can trigger unexpected machine movements that may result in serious injury or death.

- Observe the information in the appropriate product documentation before commissioning.
- Carry out a safety inspection for functions relevant to safety on the entire system, including all safety-related components.
- Ensure that the safety functions used in your drives and automation tasks are adjusted and activated through appropriate parameterizing.
- Perform a function test.
- Only put your plant into live operation once you have guaranteed that the functions relevant to safety are running correctly.

Note

Important safety notices for Safety Integrated functions

If you want to use Safety Integrated functions, you must observe the safety notices in the Safety Integrated manuals.

 **WARNING**

Malfunctions of the machine as a result of incorrect or changed parameter settings

As a result of incorrect or changed parameterization, machines can malfunction, which in turn can lead to injuries or death.

- Protect the parameterization (parameter assignments) against unauthorized access.
- Handle possible malfunctions by taking suitable measures, e.g. emergency stop or emergency off.

 **WARNING**

Injury caused by moving or ejected parts

Contact with moving motor parts or drive output elements and the ejection of loose motor parts (e.g. feather keys) out of the motor enclosure can result in severe injury or death.

- Remove any loose parts or secure them so that they cannot be flung out.
- Do not touch any moving parts.
- Safeguard all moving parts using the appropriate safety guards.

 **WARNING**

Fire due to inadequate cooling

Inadequate cooling can cause the motor to overheat, resulting in death or severe injury as a result of smoke and fire. This can also result in increased failures and reduced service lives of motors.

- Comply with the specified cooling requirements for the motor.

 **WARNING**

Fire due to incorrect operation of the motor

When incorrectly operated and in the case of a fault, the motor can overheat resulting in fire and smoke. This can result in severe injury or death. Further, excessively high temperatures destroy motor components and result in increased failures as well as shorter service lives of motors.

- Operate the motor according to the relevant specifications.
- Only operate the motors in conjunction with effective temperature monitoring.
- Immediately switch off the motor if excessively high temperatures occur.



CAUTION
Burn injuries caused by hot surfaces
In operation, the motor can reach high temperatures, which can cause burns if touched.
<ul style="list-style-type: none">• Mount the motor so that it is not accessible in operation.
Measures when maintenance is required:
<ul style="list-style-type: none">• Allow the motor to cool down before starting any work.• Use the appropriate personnel protection equipment, e.g. gloves.

1.2 Equipment damage due to electric fields or electrostatic discharge

Electrostatic sensitive devices (ESD) are individual components, integrated circuits, modules or devices that may be damaged by either electric fields or electrostatic discharge.



NOTICE
Equipment damage due to electric fields or electrostatic discharge
Electric fields or electrostatic discharge can cause malfunctions through damaged individual components, integrated circuits, modules or devices.
<ul style="list-style-type: none">• Only pack, store, transport and send electronic components, modules or devices in their original packaging or in other suitable materials, e.g. conductive foam rubber or aluminum foil.• Only touch components, modules and devices when you are grounded by one of the following methods:<ul style="list-style-type: none">– Wearing an ESD wrist strap– Wearing ESD shoes or ESD grounding straps in ESD areas with conductive flooring• Only place electronic components, modules or devices on conductive surfaces (table with ESD surface, conductive ESD foam, ESD packaging, ESD transport container).

1.3 Warranty and liability for application examples

Application examples are not binding and do not claim to be complete regarding configuration, equipment or any eventuality which may arise. Application examples do not represent specific customer solutions, but are only intended to provide support for typical tasks.

As the user you yourself are responsible for ensuring that the products described are operated correctly. Application examples do not relieve you of your responsibility for safe handling when using, installing, operating and maintaining the equipment.

1.4 Industrial security

Note

Industrial security

Siemens provides products and solutions with industrial security functions that support the secure operation of plants, systems, machines and networks.

In order to protect plants, systems, machines and networks against cyber threats, it is necessary to implement – and continuously maintain – a holistic, state-of-the-art industrial security concept. Siemens' products and solutions constitute one element of such a concept.

Customers are responsible for preventing unauthorized access to their plants, systems, machines and networks. Such systems, machines and components should only be connected to an enterprise network or the Internet if and to the extent such a connection is necessary and only when appropriate security measures (e.g. firewalls and/or network segmentation) are in place.

For additional information on industrial security measures that may be implemented, please visit:

Industrial security (<http://www.siemens.com/industrialsecurity>)

Siemens' products and solutions undergo continuous development to make them more secure. Siemens strongly recommends that product updates are applied as soon as they are available and that the latest product versions are used. Use of product versions that are no longer supported, and failure to apply the latest updates may increase customer's exposure to cyber threats.

To stay informed about product updates, subscribe to the Siemens Industrial Security RSS Feed at:

Industrial security (<http://www.siemens.com/industrialsecurity>)

Further information is provided on the Internet:

Industrial Security Configuration Manual (<https://support.industry.siemens.com/cs/ww/en/view/108862708>)

 **WARNING**

Unsafe operating states resulting from software manipulation

Software manipulations (e.g. viruses, trojans, malware or worms) can cause unsafe operating states in your system that may lead to death, serious injury, and property damage.

- Keep the software up to date.
- Incorporate the automation and drive components into a holistic, state-of-the-art industrial security concept for the installation or machine.
- Make sure that you include all installed products into the holistic industrial security concept.
- Protect files stored on exchangeable storage media from malicious software by with suitable protection measures, e.g. virus scanners.
- Protect the drive against unauthorized changes by activating the "know-how protection" drive function.

1.5 Residual risks of power drive systems

When assessing the machine- or system-related risk in accordance with the respective local regulations (e.g., EC Machinery Directive), the machine manufacturer or system installer must take into account the following residual risks emanating from the control and drive components of a drive system:

1. Unintentional movements of driven machine or system components during commissioning, operation, maintenance, and repairs caused by, for example,
 - Hardware and/or software errors in the sensors, control system, actuators, and cables and connections
 - Response times of the control system and of the drive
 - Operation and/or environmental conditions outside the specification
 - Condensation/conductive contamination
 - Parameterization, programming, cabling, and installation errors
 - Use of wireless devices/mobile phones in the immediate vicinity of electronic components
 - External influences/damage
 - X-ray, ionizing radiation and cosmic radiation
2. Unusually high temperatures, including open flames, as well as emissions of light, noise, particles, gases, etc., can occur inside and outside the components under fault conditions caused by, for example:
 - Component failure
 - Software errors
 - Operation and/or environmental conditions outside the specification
 - External influences/damage
3. Hazardous shock voltages caused by, for example:
 - Component failure
 - Influence during electrostatic charging
 - Induction of voltages in moving motors
 - Operation and/or environmental conditions outside the specification
 - Condensation/conductive contamination
 - External influences/damage
4. Electrical, magnetic and electromagnetic fields generated in operation that can pose a risk to people with a pacemaker, implants or metal replacement joints, etc., if they are too close
5. Release of environmental pollutants or emissions as a result of improper operation of the system and/or failure to dispose of components safely and correctly
6. Influence of network-connected communication systems, e.g. ripple-control transmitters or data communication via the network

For more information about the residual risks of the drive system components, see the relevant sections in the technical user documentation.

2 General information

The SINAMICS V90 drives with the PROFINET interface (referred to as SINAMICS V90 PN) are available in two variants, 400 V variant and 200 V variant.





The 200 V variant is available in four frame sizes: FSA, FSB, FSC, and FSD. Frame sizes A, B, and C are used on the single phase or three phase power network while frame size D is used on the three phase power network only.

The 400 V variant is available in four frame sizes: FSAA, FSA, FSB, and FSC. All the frame sizes are used on three phase power network only.



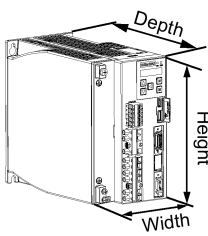



2.1 Deliverables

2.1.1 Drive components

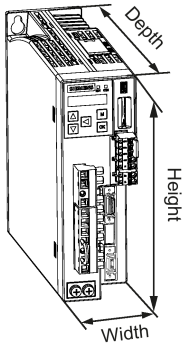
Components in the SINAMICS V90 PN 200 V variant drive package

Component	Illustration	Rated power (kW)	Outline dimension (Width x Height x Depth, mm)	Frame size	Article number
SINAMICS V90 PN, single/three-phase, 200 V		0.1/0.2	45 x 170 x 170	FSA	6SL3210-5FB10-1UF1
					6SL3210-5FB10-2UF1
		0.4	55 x 170 x 170	FSB	6SL3210-5FB10-4UF1
0.75		80 x 170 x 195	FSC	6SL3210-5FB10-8UF0	
SINAMICS V90 PN, three-phase, 200 V		1.0/1.5/2.0	95 x 170 x 195	FSD	6SL3210-5FB11-0UF1
					6SL3210-5FB11-5UF0
				6SL3210-5FB12-0UF0	
Connectors		For FSA and FSB			
		For FSC and FSD			
Shielding plate		For FSA and FSB			
		For FSC and FSD			
User documentation	Information Guide	English-Chinese bilingual version			

Components in the SINAMICS V90 PN 400 V variant drive package

Component	Illustration	Rated power (kW)	Outline dimension (Width x Height x Depth, mm)	Frame size	Article number
SINAMICS V90 PN, three-phase, 400 V		0.4	60 x 180 x 200	FSAA	6SL3210-5FE10-4UF0
		0.75/1.0	80 x 180 x 200	FSA	6SL3210-5FE10-8UF0 6SL3210-5FE11-0UF0
		1.5/2.0	100 x 180 x 220	FSB	6SL3210-5FE11-5UF0 6SL3210-5FE12-0UF0
		3.5/5.0/7.0	140 x 260 x 240	FSC	6SL3210-5FE13-5UF0
					6SL3210-5FE15-0UF0
					6SL3210-5FE17-0UF0
Connectors		For FSAA			
		For FSA			
		For FSB and FSC			
Shielding plate		For FSAA and FSA			
		For FSB and FSC			
User documentation	Information Guide	English-Chinese bilingual version			

Drive rating plate (example)

SIEMENS

① • SINAMICS V90
PROFINET (PN)

② • INPUT: 1AC/3AC 200-240V +/-10% 2.5A/1.5A 50/60Hz

③ • OUTPUT: 3AC 0-input V 1.2A 0-330Hz

④ • IP CLASS: IP20 MOTOR: 0.1kW FS: 01

⑤ • 1P 6SL3210-5FB10-1UF0 S ZVXXXXXXXXXXXX • ⑨

⑥ • MAC: 00-1C-06-00-00-01 SCCR: 65kA • ⑩

⑦ • SNC-A5E36961525 Use 75 °C Copper Wires only • ⑪

⑧ • Use in PD2 and OVC III environment only

UL LISTED

EAC

KCC-REM-S49-SINAMICS

Refer to user manual Made in China

Siemens AG, Frauenauracher Str. 80, DE-91056 Erlangen

- | | |
|---------------------|---|
| ① Drive name | ⑦ Part number |
| ② Power input | ⑧ Pollution degree and overvoltage criteria |
| ③ Power output | ⑨ Product serial number |
| ④ Rated motor power | ⑩ Rated short-circuit current |
| ⑤ Article number | ⑪ Copper wire |
| ⑥ MAC address | |

Article number explanation (example)

6 S L 3 2 1 0 - 5 F B 1 0 - 1 U F 0

Supply voltage

Symbol	Supply voltage
B	1/3 phase 200~240 VAC
E	3 phase 380~480 VAC

Drive version

Symbol	Drive version
A	V90 Pulse train (PTI) version
F	V90 PROFINET (PN) version

Supported max motor power

Symbol	Supported max motor power	Supply voltage
10-1	0.1 kW	200 V
10-2	0.2 kW	200 V
10-4	0.4 kW	200 V
	0.4 kW	400 V
10-8	0.75 kW	200 V
	0.75 kW	400 V
11-0	1.0 kW	200 V
	1.0 kW	400 V
11-5	1.5 kW	200 V
	1.75 kW	400 V
12-0	2.0 kW	200 V
	2.5 kW	400 V
13-5	3.5 kW	400 V
15-0	5.0 kW	400 V
17-0	7.0 kW	400 V

Serial number explanation (example)

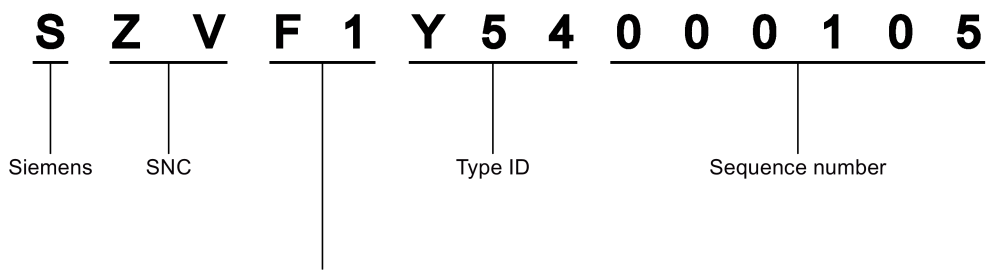

Production data (year/month)

Code *	Calendar year	Code *	Month
A	1990, 2010	1	January
B	1991, 2011	2	February
C	1992, 2012	3	March
D	1993, 2013	4	April
E	1994, 2014	5	May
F	1995, 2015	6	June
H	1996, 2016	7	July
J	1997, 2017	8	August
K	1998, 2018	9	September
L	1999, 2019	0	October
M	2000, 2020	N	November
N	2001, 2021	D	December
P	2002, 2022	* In accordance with DIN EN 60062	
R	2003, 2023		
S	2004, 2024		
T	2005, 2025		
U	2006, 2026		
V	2007, 2027		
W	2008, 2028		
X	2009, 2029		

2.1.2 Motor components

Components in the SIMOTICS S-1FL6 low inertia motor package

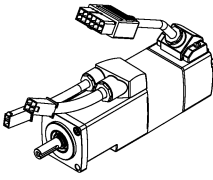
Component	Illustration	Rated power (kW)	Shaft height (mm)	Article number	
SIMOTICS S-1FL6, low inertia		0.05/0.1	20	1FL6022-2AF21-1□□1 1FL6024-2AF21-1□□1	
		0.2/0.4	30	1FL6032-2AF21-1□□1 1FL6034-2AF21-1□□1	
				1FL6042-2AF21-1□□1 1FL6044-2AF21-1□□1	
		1.5/2.0	50	1FL6052-2AF21-0□□1 1FL6054-2AF21-0□□1	
				1.5/2.0	50
	User documentation	SIMOTICS S-1FL6 Servo Motors Installation Guide			

Components in the SIMOTICS S-1FL6 high inertia motor package

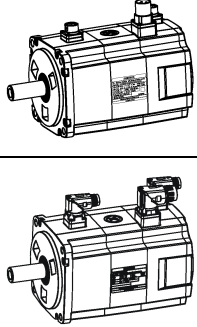
Component	Illustration	Rated power (kW)	Shaft height (mm)	Article number		
SIMOTICS S-1FL6, high inertia		0.4/0.75	45	1FL6042-1AF61-□□□1		
				1FL6044-1AF61-□□□1		
		0.75/1.0/1.5/1.75/2.0	65	1FL6061-1AC61-□□□1		
				1FL6062-1AC61-□□□1		
				1FL6064-1AC61-□□□1		
				1FL6066-1AC61-□□□1		
				1FL6067-1AC61-□□□1		
		2.5/3.5/5.0/7.0	90	1FL6090-1AC61-□□□1		
				1FL6092-1AC61-□□□1		
				1FL6094-1AC61-□□□1		
				1FL6096-1AC61-□□□1		
				Straight connectors with a fixed outlet direction	0	
				Angular connectors with a flexible outlet direction	2	
		User documentation	SIMOTICS S-1FL6 Servo Motors Installation Guide			

Motor rating plate (example)

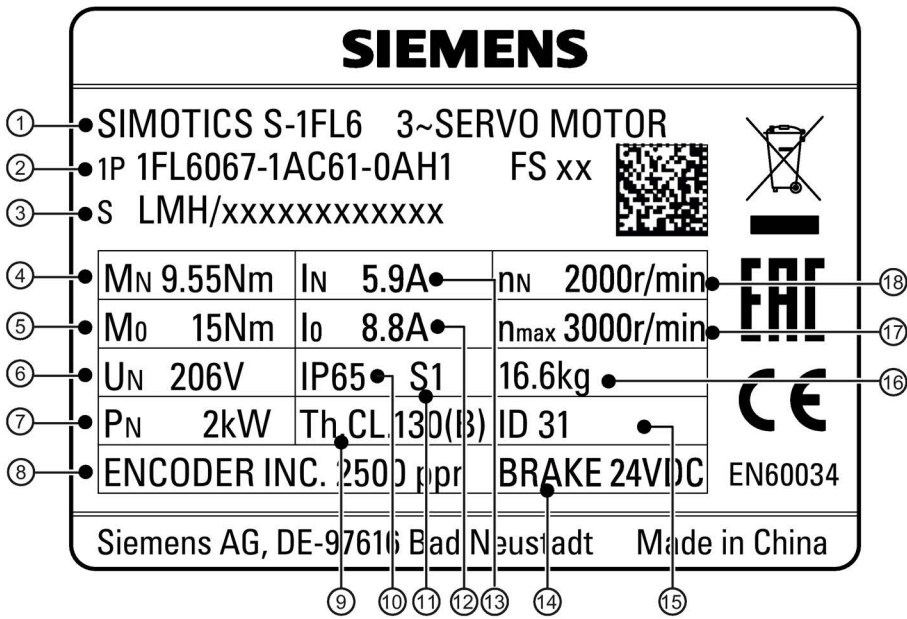

- | | |
|-------------------------------|------------------------|
| ① Motor type | ⑩ Degree of protection |
| ② Article number | ⑪ Motor operating mode |
| ③ Serial number | ⑫ Stall current |
| ④ Rated torque | ⑬ Rated current |
| ⑤ Stall torque | ⑭ Holding brake |
| ⑥ Rated voltage | ⑮ Motor ID |
| ⑦ Rated power | ⑯ Weight |
| ⑧ Encoder type and resolution | ⑰ Maximum speed |
| ⑨ Thermal class | ⑱ Rated speed |

Article number explanation

1 F L 6 0 6 7 - 1 A C 6 1 - 0 A H 1

Shaft height (SH)

Symbol	SH	Inertia type
02	20 mm	Low
03	30 mm	Low
04	40 mm	Low
	45 mm	High
05	50 mm	Low
06	65 mm	High
09	90 mm	High

Inertia type

Symbol	Type
1	High
2	Low

Supply voltage

Symbol	Voltage
2	200 V
6	400 V

Rated speed

Symbol	Rated speed
C	2000 rpm
F	3000 rpm

Rated torque

Symbol	Rated torque, SH
0	11.9 Nm, SH90
1	3.58 Nm, SH65
2	0.16 Nm, SH20
	0.64 Nm, SH30
	1.27 Nm, SH45
	2.39 Nm, SH40
	4.78 Nm, SH50
	4.78 Nm, SH65
	16.7 Nm, SH90
4	0.32 Nm, SH20
	1.27 Nm, SH30
	2.39 Nm, SH45
	3.18 Nm, SH40
	6.37 Nm, SH50
	7.16 Nm, SH65
	23.9 Nm, SH90
6	8.36 Nm, SH65
	33.4 Nm, SH90
7	9.55 Nm, SH65

Connection type

Symbol	Connection type
0	Straight connectors with a fixed outlet direction
1	Cable outlet
2	Angular connectors with a flexible outlet direction

Encoder type

Symbol	Encoder type
A	Incremental encoder TTL 2500 ppr
M	Absolute encoder single-turn 21-bit
L	Absolute encoder 20-bit + 12-bit multi-turn

Mechanics

Symbol	Mechanics
G	Plain shaft, without brake
H	Plain shaft, with brake
A	Shaft with key (half-key balancing), without brake
B	Shaft with key (half-key balancing), with brake

Protection degree

Symbol	Protection degree
1	IP65, with shaft oil seal

2.2 Device combination

V90 PN 200 V servo system

SIMOTICS S-1FL6 low inertia servo motors					SINAMICS V90 PN 200 V servo drives			MOTION-CONNECT 300 pre-assembled cables				
Rated torque (Nm)	Rated power (kW)	Rated speed (rpm)	Shaft height (mm)	Article No. 1FL60		Article No. 6SL321 0-5	Frame size	Power cable	Brake cable	Encoder cable		
								Article No. 6FX3002-5	Article No. 6FX3002-5	Article No. 6FX3002-2		
0.16	0.05	3000	20	22-2AF21-1	<input type="checkbox"/>	<input type="checkbox"/>	FB10-1UF1	FSA	CK01-1AD0 (3 m)	BK02-1AD0 (3 m)	<input type="checkbox"/>	20-1AD0 (3 m)
0.32	0.1	3000		24-2AF21-1	<input type="checkbox"/>	<input type="checkbox"/>						
0.64	0.2	3000	30	32-2AF21-1	<input type="checkbox"/>	<input type="checkbox"/>	FB10-4UF1	FSC	CK01-1BA0 (10 m)	BK02-1BA0 (10 m)	20-1BA0 (10 m)	
1.27	0.4	3000		34-2AF21-1	<input type="checkbox"/>	<input type="checkbox"/>						FB10-8UF0
2.39	0.75	3000	40	42-2AF21-1	<input type="checkbox"/>	<input type="checkbox"/>	FB11-0UF1	FSD	CK31-1AD0 (3 m)	BL02-1AD0 (3 m)	<input type="checkbox"/>	
3.18	1	3000		44-2AF21-1	<input type="checkbox"/>	<input type="checkbox"/>						FB12-0UF0
4.78	1.5	3000	50	52-2AF21-0 ¹⁾	<input type="checkbox"/>	<input type="checkbox"/>	FB11-5UF0	FSD	CK31-1BA0 (10 m)	BL02-1BA0 (10 m)	10-1BA0 (10 m)	
6.37	2	3000		54-2AF21-0 ¹⁾	<input type="checkbox"/>	<input type="checkbox"/>						FB12-0UF0
4.78	1.5	3000	50	52-2AF21-2 ²⁾	<input type="checkbox"/>	<input type="checkbox"/>	FB11-5UF0	FSD	CK32-1AD0 (3 m)	BL03-1AD0 (3 m)	<input type="checkbox"/>	
6.37	2	3000		54-2AF21-2 ²⁾	<input type="checkbox"/>	<input type="checkbox"/>						FB12-0UF0
									CK32-1BA0 (10 m)	BL03-1BA0 (10 m)	12-1BA0 (10 m)	
									CK32-1CA0 (20 m)	BL03-1CA0 (20 m)	12-1CA0 (20 m)	
Incremental encoder TTL 2500 ppr					A				Incremental encoder TTL 2500 ppr		CT	
Absolute encoder single-turn 21-bit					M				Absolute encoder single-turn 21-bit		DB	

- 1) Low inertia motor with straight connectors
 2) Low inertia motor with angular connectors

V90 PN 400 V servo system

SIMOTICS S-1FL6 high inertia servo motors with straight connectors						SINAMICS V90 PN 400 V servo drives			MOTION-CONNECT 300 pre-assembled cables				
Rated torque (Nm)	Rated power (kW)	Rated speed (rpm)	Shaft height (mm)	Article No. 1FL60		Article No. 6SL321 0-5	Frame size	Article No. 6FX3002-5	Article No. 6FX3002-5	Encoder cable			
				<input type="checkbox"/>	<input type="checkbox"/>					<input type="checkbox"/>	<input type="checkbox"/>		
1.27	0.4	3000	45	42-1AF61-0	<input type="checkbox"/>	<input type="checkbox"/>	FE10-4UF0	FSA	CL01-1AD0 (3 m)	BL02-1AD0 (3 m)	<input type="checkbox"/>	10-1AD0 (3 m)	
2.39	0.75	3000		44-1AF61-0	<input type="checkbox"/>	<input type="checkbox"/>	FE10-8UF0	FSA	CL01-1AF0 (5 m)	BL02-1AF0 (5 m)			10-1AF0 (5 m)
3.58	0.75	2000	65	61-1AC61-0	<input type="checkbox"/>	<input type="checkbox"/>	FE11-0UF0	FSB	CL01-1AH0 (7 m)	BL02-1AH0 (7 m)	<input type="checkbox"/>	10-1AH0 (7 m)	
4.78	1.0	2000		62-1AC61-0	<input type="checkbox"/>	<input type="checkbox"/>			CL01-1BA0 (10 m)	BL02-1BA0 (10 m)			10-1BA0 (10 m)
7.16	1.5	2000		64-1AC61-0	<input type="checkbox"/>	<input type="checkbox"/>	FE11-5UF0		CL11-1AD0 (3 m)	BL02-1BF0 (15 m)			10-1BF0 (15 m)
8.36	1.75	2000		66-1AC61-0	<input type="checkbox"/>	<input type="checkbox"/>	FE12-0UF0		CL11-1AF0 (5 m)	BL02-1CA0 (20 m)			10-1CA0 (20 m)
9.55	2.0	2000		67-1AC61-0	<input type="checkbox"/>	<input type="checkbox"/>			CL11-1AH0 (7 m)				
11.9	2.5	2000		90	90-1AC61-0	<input type="checkbox"/>	<input type="checkbox"/>		CL11-1BA0 (10 m)				
16.7	3.5	2000		92-1AC61-0	<input type="checkbox"/>	<input type="checkbox"/>	FE13-5UF0		FSC	CL11-1BF0 (15 m)			
23.9	5.0	2000	94-1AC61-0	<input type="checkbox"/>	<input type="checkbox"/>	FE15-0UF0		CL11-1CA0 (20 m)					
33.4	7.0	2000	96-1AC61-0	<input type="checkbox"/>	<input type="checkbox"/>	FE17-0UF0							
Incremental encoder TTL 2500 ppr					A				Incremental encoder TTL 2500 ppr	CT			
Absolute encoder 20-bit + 12-bit multi-turn					L				Absolute encoder 20-bit + 12-bit multi-turn	DB			

SIMOTICS S-1FL6 high inertia servo motors with angular connectors					SINAMICS V90 PN 400 V servo drives			MOTION-CONNECT 300 pre-assembled cables						
Rated torque (Nm)	Rated power (kW)	Rated speed (rpm)	Shaft height (mm)	Article No. 1FL60			Article No. 6SL321 0-5	Frame size	Power cable	Brake cable	Encoder cable			
									Article No. 6FX3002-5	Article No. 6FX3002-5	Article No. 6FX3002-2			
1.27	0.4	3000	45	42-1AF61-2	<input type="checkbox"/>	<input type="checkbox"/>	FE10-4UF0	FSA	CL02-1AD0 (3 m)	BL03-1AD0 (3 m)	<input type="checkbox"/> <input type="checkbox"/> <input type="checkbox"/>	-1AD0 (3 m)		
2.39	0.75	3000		44-1AF61-2	<input type="checkbox"/>	<input type="checkbox"/>	FE10-8UF0	FSA				CL02-1AF0 (5 m)	BL03-1AF0 (5 m)	-1AF0 (5 m)
3.58	0.75	2000	65	61-1AC61-2	<input type="checkbox"/>	<input type="checkbox"/>	FE11-0UF0	FSB	CL02-1AH0 (7 m)	BL03-1AH0 (7 m)	<input type="checkbox"/>	-1AH0 (7 m)		
4.78	1.0	2000		62-1AC61-2	<input type="checkbox"/>	<input type="checkbox"/>						CL02-1BA0 (10 m)	BL03-1BA0 (10 m)	-1BA0 (10 m)
7.16	1.5	2000		64-1AC61-2	<input type="checkbox"/>	<input type="checkbox"/>	FE11-5UF0					CL12-1AD0 (3 m)	BL03-1BF0 (15 m)	-1BF0 (15 m)
8.36	1.75	2000		66-1AC61-2	<input type="checkbox"/>	<input type="checkbox"/>	FE12-0UF0					CL12-1AF0 (5 m)		-1CA0 (20 m)
9.55	2.0	2000		67-1AC61-2	<input type="checkbox"/>	<input type="checkbox"/>						CL12-1AH0 (7 m)		
11.9	2.5	2000		90-1AC61-2	<input type="checkbox"/>	<input type="checkbox"/>						CL12-1BA0 (10 m)		
16.7	3.5	2000	92-1AC61-2	<input type="checkbox"/>	<input type="checkbox"/>	FE13-5UF0	FSC	CL12-1BF0 (15 m)						
23.9	5.0	2000	94-1AC61-2	<input type="checkbox"/>	<input type="checkbox"/>	FE15-0UF0	CL12-1CA0 (20 m)							
33.4	7.0	2000	96-1AC61-2	<input type="checkbox"/>	<input type="checkbox"/>	FE17-0UF0								
Incremental encoder TTL 2500 ppr					A				Incremental encoder TTL 2500 ppr		CT12			
Absolute encoder 20-bit + 12-bit multi-turn					L				Absolute encoder 20-bit + 12-bit multi-turn		DB10			

Note

You can select a SINAMICS V90 PN servo drive for all the SIMOTICS S-1FL6 servo motors whose rated power values are equal to or smaller than that specified as matching with this servo drive in the table above.

2.3 Accessories

Fuse/Type-E combination motor controller

A fuse/type-E combination motor controller/circuit breaker can be used to protect the system. Integral solid state short circuit protection does not provide branch circuit protection. Branch circuit protection must be provided in accordance with the National Electrical Code and any additional local codes. Refer to the following table for the selection of fuses, type-E combination motor controllers, and circuit breakers:

SINAMICS V90 PN 200 V variant

SINAMICS V90 PN		Recommended fuse		Type-E combination motor controller ¹⁾			
Frame size	Rated power (kW)	CE-compliant	UL/cUL-compliant listed (JDDZ) fuse	Rated current (A)	Rated voltage (VAC)	Rated power (hp)	Article number
1-phase, 200 VAC to 240 VAC							
FSA	0.1	3NA3 801 (6 A)	6 A	2.8 to 4	230/240	1/3	3RV 2011-1EA10
	0.2	3NA3 801 (6 A)	6 A	2.8 to 4	230/240	1/3	3RV 2011-1EA10
FSB	0.4	3NA3 803 (10 A)	10 A	5.5 to 8	230/240	1	3RV 2011-1HA10
FSC	0.75	3NA3 805 (16 A)	20 A	9 to 12.5	230/240	2	3RV 2011-1KA10
3-phase, 200 VAC to 240 VAC							
FSA	0.1	3NA3 801 (6 A)	6 A	2.8 to 4	230/240	3/4	3RV 2011-1EA10
	0.2	3NA3 801 (6 A)	6 A	2.8 to 4	230/240	3/4	3RV 2011-1EA10
FSB	0.4	3NA3 803 (10 A)	10 A	2.8 to 4	230/240	3/4	3RV 2011-1EA10
FSC	0.75	3NA3 805 (16 A)	20 A	5.5 to 8	230/240	2	3RV 2011-1HA10
FSD	1.0	3NA3 805 (16 A)	20 A	7 to 10	230/240	3	3RV 2011-1JA10
	1.5	3NA3 810 (25 A)	25 A	10 to 16	230/240	5	3RV 2011-4AA10
	2.0	3NA3 810 (25 A)	25 A	10 to 16	230/240	5	3RV 2011-4AA10

¹⁾ The above types for type-E combination motor controllers are listed in compliance with both CE and UL/cUL standards.

SINAMICS V90 PN 400 V variant

SINAMICS V90 PN		Recommended fuse type		Type-E combination motor controller ¹⁾			
Frame size	Rated power (kW)	CE-compliant	UL/cUL-compliant listed (JDDZ) fuse	Rated current (A)	Rated voltage (VAC)	Rated power (hp)	Article number
3-phase, 380 VAC to 480 VAC							
FSA	0.4	3NA3 801-6 (6 A)	10 A	2.2 to 3.2	380/480	0.5	3RV 2021-1DA10
FSA	0.75	3NA3 801-6 (6 A)	10 A	2.8 to 4	380/480	1	3RV 2021-1EA10
	1.0	3NA3 803-6 (10 A)	10 A	3.5 to 5	380/480	1.34	3RV 2021-1FA10
FSB	1.5	3NA3 803-6 (10 A)	15 A	5.5 to 8	380/480	2	3RV 2021-1HA10
	2.0	3NA3 805-6 (16 A)	15 A	11 to 16	380/480	2.68	3RV 2021-4AA10

SINAMICS V90 PN		Recommended fuse type		Type-E combination motor controller ¹⁾			
Frame size	Rated power (kW)	CE-compliant	UL/cUL-compliant listed (JDDZ) fuse	Rated current (A)	Rated voltage (VAC)	Rated power (hp)	Article number
FSC	3.5	3NA3 807-6 (20 A)	25 A	14 to 20	380/480	4.7	3RV 2021-4BA10
	5.0	3NA3 807-6 (20 A)	25 A	14 to 20	380/480	6.7	3RV 2021-4BA10
	7.0	3NA3 810-6 (25 A)	25 A	20 to 25	380/480	9.4	3RV 2021-4DA10

¹⁾ The above types for Type-E combination motor controllers are listed in compliance with both CE and UL/cUL standards. For more information about the accessories, refer to SINAMICS V90, SIMOTICS S-1FL6 Operating Instructions.

 WARNING
<p>Requirements for United States/Canadian installations (UL/cUL)</p> <p>Suitable for use on a circuit capable of delivering not more than 65000 rms Symmetrical Amperes, 480 VAC maximum for 400 V variants of drives or 240 VAC maximum for 200 V variant drives, when protected by UL/cUL listed (JDDZ) fuse or type E combination motor controller. For each frame size AA, A, B, C and D, use 75 °C copper wire only.</p> <p>This equipment is capable of providing internal motor overload protection according to UL508C.</p> <p>For Canadian (cUL) installations the drive mains supply must be fitted with any external recommended suppressor with the following features:</p> <ul style="list-style-type: none"> • Surge-protective devices; device shall be a Listed Surge-protective device (Category code VZCA and VZCA7) • Rated nominal voltage 480/277 VAC, 50/60 Hz, 3-phase • Clamping voltage VPR = 2000 V, IN = 3kA min, MCOV = 508 VAC, SCCR = 65 kA • Suitable for Type 2 SPD application • Clamping shall be provided between phases and also between phase and ground

Product maintenance

The components are subject to continuous further development within the scope of product maintenance (improvements to robustness, discontinuations of components, etc).

These further developments are "spare parts-compatible" and do not change the article number.

In the scope of such spare parts-compatible further developments, connector positions are sometimes changed slightly. This does not cause any problems with proper use of the components. Please take this fact into consideration in special installation situations (e.g. allow sufficient clearance for the cable length).

Use of third-party products

This document contains recommendations relating to third-party products. Siemens accepts the fundamental suitability of these third-party products.

You can use equivalent products from other manufacturers.

Siemens does not accept any warranty for the properties of third-party products.

Environmental protection



Waste electrical products cannot be disposed of with household waste. Please recycle where facilities exist. Check with your local authority or retailer for recycling advice.

2.4 Function list

Function	Description	Control mode
Basic positioner (EPOS)	Positions axes in absolute/relative terms with a motor encoder	EPOS
Speed control (S)	Flexibly controls motor speed and direction through PROFINET communication port	S
Safe Torque Off (STO)	Safely disconnects torque-generating motor power supply to prevent an unintentional motor restart	EPOS, S
One-button auto tuning	Estimates the machine characteristic and sets the closed loop control parameters (speed loop gain, speed integral compensation, filter if necessary, etc.) without any user intervention	EPOS, S
Real-time auto tuning	Estimates the machine characteristic and sets the closed loop control parameters (speed loop gain, speed integral compensation, filter if necessary, etc.) continuously in real time without any user intervention	EPOS, S
Resonance suppression	Suppresses the mechanical resonance, such as workpiece vibration and base shake	EPOS, S
Low frequency vibration suppression	Suppresses the low frequency vibration in the machine system	EPOS
Speed limit	Limits motor speed through internal speed limit commands (two groups)	EPOS, S
Torque limit	Limits motor torque through internal torque limit commands (two groups)	EPOS, S
Basic operator panel (BOP)	Displays servo status on a 6-digit 7-segment LED display	EPOS, S
External braking resistor - DCP, R1	An external braking resistor can be used when the internal braking resistor is insufficient for regenerative energy	EPOS, S
Digital inputs/outputs (Dis/Dos)	Control signals and status signals can be assigned to four programmable digital inputs and two digital outputs	EPOS, S
PROFINET communication	Supports communication between the SINAMICS V90 PN servo drive and PLC with PROFINET communication protocol	EPOS, S
SINAMICS V-ASSISTANT	You can perform parameter settings, test operation, adjustment and other operations with a PC	EPOS, S

2.5 Technical data

2.5.1 Technical data - servo drives

General technical data

Parameter	Description
24 VDC power supply	Voltage (V)
	Maximum current (A)
Overload capability	24 (-15% to +20%) ¹⁾ When using a motor without a brake: 1.5 A When using a motor with a brake: 1.5 A + motor holding brake rated current (See Section "Technical data - servo motors (Page 25)".)
Overload capability	300%
Control system	Servo control
Dynamic brake	Built-in
Protective functions	Earthing fault protection, output short-circuit protection ²⁾ , overvoltage/undervoltage protection ³⁾ , I ² t inverter, I ² t motor, IGBT overtemperature protection ⁴⁾
Overvoltage criteria	Category III

Parameter		Description	
Speed control mode	Speed control range	Internal speed command 1:5000	
	Torque limit	Set through a parameter	
Environmental conditions	Surrounding air temperature	Operation	0 °C to 45 °C: without power derating 45 °C to 55 °C: with power derating
		Storage	-40 °C to +70 °C
	Ambient humidity	Operation	< 90% (non-condensing)
		Storage	90% (non-condensing)
	Operating environment		Indoors (without direct sunlight), free from corrosive gas, combustible gas, oil gas, or dust
	Altitude		≤ 1000 m (without power derating)
	Degree of protection		IP 20
	Degree of pollution		Class 2
Vibration	Operation	Shock	Operational area II Peak acceleration: 5 g, 30 ms and 15 g, 11 ms Quantity of shocks: 3 per direction × 6 directions Duration of shock: 1 s
		Vibration	Operational area II 10 Hz to 58 Hz: 0.075 mm deflection 58 Hz to 200 Hz: 1 g vibration
	Product packaging	Vibration	2 Hz to 9 Hz: 3.5 mm deflection 9 Hz to 200 Hz: 1 g vibration Quantity of cycles: 10 per axis Sweep seed: 1 octave/min
Certification	UL, CE, KC, C-Tick, EAC		

- 1) When SINAMICS V90 PN works with a motor with a brake, the voltage tolerance of 24 VDC power supply must be -10% to +10% to meet the voltage requirement of the brake.
- 2) Integral solid state short circuit protection does not provide branch circuit protection. Branch circuit protection must be provided in accordance with the National Electrical Code and any additional local codes.
- 3) The V90 PN 200 V servo drive has an overvoltage threshold of 410 VDC and an undervoltage threshold of 150 VDC; the V90 PN 400 V servo drive has an overvoltage threshold of 820 VDC and an undervoltage threshold of 320 VDC.
- 4) SINAMICS V90 PN does not support motor overtemperature protection. Motor overtemperature is calculated by I^2t and protected by the output current from the drive.

Specific technical data

SINAMICS V90 PN 200V variant

Article No.	6SL3210-5FB...	10-1UF1	10-2UF1	10-4UF1	10-8UF0	11-0UF1	11-5UF0	12-0UF0
Frame size		FSA	FSA	FSB	FSC	FSD	FSD	FSD
Rated output current (A)		1.2	1.4	2.6	4.7	6.3	10.6	11.6
Max. output current (A)		3.6	4.2	7.8	14.1	18.9	31.8	34.8
Max. supported motor power (kW)		0.1	0.2	0.4	0.75	1.0	1.5	2.0
Power loss ¹⁾	Main circuit (W)	8	15	33	48	65	105	113
	Regenerative resistor (W)	5	5	7	9	13	25	25
	Control circuit (W)	16	16	16	16	16	18	18
	Total (W)	29	36	56	73	94	148	156

Article No.	6SL3210-5FB...	10-1UF1	10-2UF1	10-4UF1	10-8UF0	11-0UF1	11-5UF0	12-0UF0	
Frame size		FSA	FSA	FSB	FSC	FSD	FSD	FSD	
Output frequency (Hz)		0 to 330							
Power supply	Voltage/frequency	FSA, FSB and FSC: single phase/three phase 200 VAC to 240 VAC, 50/60 Hz FSD: three phase 200 VAC to 240 VAC, 50/60 Hz							
	Permissible voltage fluctuation	-15% to +10%							
	Permissible frequency fluctuation	-10% to +10%							
	Permissible supply configuration	TN, TT, IT							
	Rated input current (A)	1-phase	2.5	3.0	5.0	10.4	-	-	-
		3-phase	1.5	1.8	3.0	5.0	7.0	11.0	12.0
	Power supply capacity (kVA)	1-phase	0.5	0.7	1.2	2.0	-	-	-
3-phase		0.5	0.7	1.1	1.9	2.7	4.2	4.6	
Inrush current (A)		8.0							
Cooling method		Self-cooled				Fan-cooled			
Mechanical design	Outline dimensions (W x H x D, mm)	45 x 170 x 170		55 x 170 x 170	80 x 170 x 195	95 x 170 x 195			
		Weight (kg)		1.1	1.25	1.95	2.3	2.4	

1) The values here are calculated at rated load.

SINAMICS V90 PN 400V variant

Article No.	6SL3210-5FE...	10-4UF0	10-8UF0	11-0UF0	11-5UF0	12-0UF0	13-5UF0	15-0UF0	17-0UF0
Frame size		FSA	FSA	FSA	FSB	FSB	FSC	FSC	FSC
Rated output current (A)		1.2	2.1	3.0	5.3	7.8	11.0	12.6	13.2
Max. output current (A)		3.6	6.3	9.0	13.8	23.4	33.0	37.8	39.6
Max. supported motor power (kW)		0.4	0.75	1.0	1.75	2.5	3.5	5.0	7.0
Power loss ¹⁾	Main circuit (W)	12	29	32	84	96	92	115	138
	Regenerative resistor (W)	17	57	57	131	131	339	339	339
	Control circuit (W)	32	32	35	35	35	36	36	36
	Total (W)	61	118	124	250	262	467	490	513
Output frequency (Hz)		0 to 330							
Power supply	Voltage/frequency	Three phase 380 VAC to 480 VAC, 50/60 Hz							
	Permissible voltage fluctuation	-15% to +10%							
	Permissible frequency fluctuation	-10% to +10%							
	Permissible supply configuration	TN, TT, IT							
	Rated input current (A)	1.5	2.6	3.8	6.6	9.8	13.8	15.8	16.5
	Power supply capacity (kVA)	1.7	3.0	4.3	7.6	11.1	15.7	18.0	18.9
	Inrush current (A)		8.0	8.0	8.0	4.0	4.0	2.5	2.5

Article No.	6SL3210-5FE...	10-4UF0	10-8UF0	11-0UF0	11-5UF0	12-0UF0	13-5UF0	15-0UF0	17-0UF0
Frame size		FSAA	FSA	FSA	FSB	FSB	FSC	FSC	FSC
Cooling method		Self-cooled			Fan-cooled				
Mechanical design	Outline dimensions (W x H x D, mm)	60 x 180 x 200	80 x 180 x 200		100 x 180 x 220		140 x 260 x 240		
Weight (kg)		1.5	1.9	1.9	2.5	2.5	5.0	5.5	5.75

1) The values here are calculated at rated load.

2.5.2 Technical data - servo motors

General technical data

Parameter	Description
Type of motor	Permanent-magnet synchronous motor
Cooling	Self-cooled
Relative humidity [RH]	90% (non-condensing at 30°C)
Installation altitude [m]	≤ 1000 (without power derating)
Thermal class	B
Vibration severity grade	A (according to IEC 60034-14)
Shock resistance [m/s ²]	25 (continuous in axial direction); 50 (continuous in radial direction); 250 (in a short time of 6 ms)
Bearing lifetime [h]	> 20000 ¹⁾
Paint finish	Black
Protection degree of shaft	IP 65, with shaft oil seal
Type of construction	IM B5, IM V1, and IM V3
Positive rotation	Clockwise (default setting in servo drives)
Certification	CE, EAC

1) This lifetime is only for reference. When a motor keeps running at rated speed under rated load, replace its bearing after 20,000 to 30,000 hours of service time. Even if the time is not reached, the bearing must be replaced when unusual noise, vibration, or faults are found.

Specific technical data

SIMOTICS S-1FL6, low inertia servo motor

Article No.	1FL60...	22	24	32	34	42	44	52	54
Rated power [kW]		0.05	0.1	0.2	0.4	0.75	1	1.5	2
Rated torque [Nm]		0.16	0.32	0.64	1.27	2.39	3.18	4.78	6.37
Maximum torque [Nm]		0.48	0.96	1.91	3.82	7.2	9.54	14.3	19.1
Rated speed [rpm]		3000							
Maximum speed [rpm]		5000							
Rated frequency [Hz]		200							
Rated current [A]		1.2	1.2	1.4	2.6	4.7	6.3	10.6	11.6
Maximum current [A]		3.6	3.6	4.2	7.8	14.2	18.9	31.8	34.8
Moment of inertia [10 ⁻⁴ kgm ²]		0.031	0.052	0.214	0.351	0.897	1.15	2.04	2.62
Moment of inertia (with brake) [10 ⁻⁴ kgm ²]		0.038	0.059	0.245	0.381	1.06	1.31	2.24	2.82
Recommended load to motor inertia ratio		Max. 30x				Max. 20x		Max. 15x	

Article No.	1FL60...	22	24	32	34	42	44	52	54
Operating temperature [°C]		1FL602□, 1FL603□ and 1FL604□: 0 to 40 (without power derating) 1FL605□: 0 to 30 (without power derating) ¹⁾							
Storage temperature [°C]		-20 to +65							
Maximum noise level [dB]		60							
Holding brake	Rated voltage (V)	24 ± 10%							
	Rated current (A)	0.25		0.3		0.35		0.57	
	Holding brake torque [Nm]	0.32		1.27		3.18		6.37	
	Maximum brake opening time [ms]	35		75		105		90	
	Maximum brake closing time [ms]	10		10		15		35	
	Maximum number of emergency stops	2000 ²⁾							
Oil seal lifetime [h]		3000 to 5000							
Encoder lifetime [h]		> 20000 ³⁾							
Protection degree of motor body		IP 65							
Protection degree of cable end connector		IP20						-	
Weight [kg]	With brake	0.7	0.9	1.5	1.9	3.7	4.2	6.8/7.0 ⁴⁾	8.0/8.2 ⁴⁾
	Without brake	0.5	0.6	1.0	1.5	2.8	3.4	5.4/5.5 ⁴⁾	6.6/6.7 ⁴⁾

- 1) When the surrounding temperature is between 30 °C and 40 °C, the 1FL605 motor will have a power derating of 10%.
- 2) Restricted emergency stop operation is permissible. Up to 2000 braking operations for the motors of 0.05 kW to 1 kW, and 200 braking operations for the motors of 1.5 kW to 2 kW can be executed with 300% rotor moment of inertia as external moment of inertia from a speed of 3000 rpm without the brake being subject to an inadmissible amount of wear.
- 3) This lifetime is only for reference. When a motor keeps running at 80% rated value and the surrounding temperature is 30 °C, the encoder lifetime can be ensured.
- 4) The former value indicates the data for low inertia motors with straight connectors; the latter value indicates the data for low inertia motors with angular connectors.

Note

The data of rated torque, rated power, maximum torque in the above table allows a tolerance of 10%.

SIMOTICS S-1FL6, high inertia servo motor

Article No.	1FL60...	42	44	61	62	64	66	67	90	92	94	96	
Rated power [kW]		0.40	0.75	0.75	1.00	1.50	1.75	2.00	2.5	3.5	5.0	7.0 ¹⁾	
Rated torque [Nm]		1.27	2.39	3.58	4.78	7.16	8.36	9.55	11.9	16.7	23.9	33.4	
Maximum torque [Nm]		3.8	7.2	10.7	14.3	21.5	25.1	28.7	35.7	50.0	70.0	90.0	
Rated speed [rpm]		3000		2000					2000				
Maximum speed [rpm]		4000		3000					3000		2500	2000	
Rated frequency [Hz]		200		133					133				
Rated current [A]		1.2	2.1	2.5	3.0	4.6	5.3	5.9	7.8	11.0	12.6	13.2	
Maximum current [A]		3.6	6.3	7.5	9.0	13.8	15.9	17.7	23.4	33.0	36.9	35.6	

Article No.	1FL60...	42	44	61	62	64	66	67	90	92	94	96
Moment of inertia [10 ⁻⁴ kgm ²]		2.7	5.2	8.0	15.3/1 1.7 ²⁾	15.3	22.6	29.9	47.4	69.1	90.8	134.3
Moment of inertia (with brake) [10 ⁻⁴ kgm ²]		3.2	5.7	9.1	16.4/1 3.5 ²⁾	16.4	23.7	31.0	56.3	77.9	99.7	143.2
Recommended load to motor inertia ratio		Max. 10x		Max. 5x				Max. 5x				
Operating temperature [°C]	0 to 40 (without power derating)											
Storage temperature [°C]	-20 to +65											
Maximum noise level [dB]	65			70				70				
Holding brake	Rated voltage (V)	24 ± 10%										
	Rated current (A)	0.88		1.44				1.88				
	Holding brake torque [Nm]	3.5		12				30				
	Maximum brake opening time [ms]	60		180				220				
	Maximum brake closing time [ms]	45		60				115				
	Maximum number of emergency stops	2000 ³⁾										
Oil seal lifetime [h]	5000											
Encoder lifetime [h]	> 20000 ⁴⁾											
Degree of protection	IP65, with shaft oil seal											
Weight of incremental encoder motor [kg]	With brake ²⁾	4.6/ 4.8	6.4/ 6.6	8.6/ 8.8	11.3/ 10.1	11.3/ 11.5	14.0/ 14.2	16.6/ 16.8	21.3/ 21.5	25.7/ 25.9	30.3/ 30.5	39.1/ 39.3
	Without brake ²⁾	3.3/ 3.4	5.1/ 5.2	5.6/ 5.7	8.3/ 7.0	8.3/ 8.4	11.0/ 11.1	13.6/ 13.7	15.3/ 15.4	19.7/ 19.8	24.3/ 24.4	33.2/ 33.3
Weight of absolute encoder motor [kg]	With brake ²⁾	4.4/ 4.5	6.2/ 6.3	8.3/ 8.4	11.0/ 9.7	11.0/ 11.1	13.6/ 13.7	16.3/ 16.4	20.9/ 21.0	25.3/ 25.4	29.9/ 30.0	38.7/ 38.8
	Without brake ²⁾	3.1/ 3.2	4.9/ 5.0	5.3/ 5.4	8.0/ 6.7	8.0/ 8.1	10.7/ 10.8	13.3/ 13.4	14.8/ 14.9	19.3/ 19.4	23.9/ 24.0	32.7/ 32.8

- 1) When the surrounding temperature is higher than 30 °C, the 1FL6096 motors with brake will have a power derating of 10%.
- 2) The former value indicates the data for high inertia motors with straight connectors; the latter value indicates the data for high inertia motors with angular connectors.
- 3) Restricted emergency stop operation is permissible. Up to 2000 braking operations can be executed with 300% rotor moment of inertia as external moment of inertia from a speed of 3000 rpm without the brake being subject to an inadmissible amount of wear.
- 4) This lifetime is only for reference. When a motor keeps running at 80% rated value and the surrounding temperature is 30 °C, the encoder lifetime can be ensured.

Note

The data of rated torque, rated power, and maximum torque in the above table allows a tolerance of 10%.

Power derating

For deviating conditions (surrounding temperature > 40 °C or installation altitude > 1000 m above sea level) the permissible torque/power must be determined from the following table. Surrounding temperatures and installation altitudes are rounded off to 5 °C and 500 m respectively.

Power derating as a function of the installation altitude and ambient temperature

Installation altitude above sea level (m)	Surrounding temperature in °C				
	< 30	30 to 40	45	50	55
1000	1.07	1.00	0.96	0.92	0.87
1500	1.04	0.97	0.93	0.89	0.84
2000	1.00	0.94	0.90	0.86	0.82
2500	0.96	0.90	0.86	0.83	0.78
3000	0.92	0.86	0.82	0.79	0.75
3500	0.88	0.82	0.79	0.75	0.71
4000	0.82	0.77	0.74	0.71	0.67

2.5.3 Address of CE-authorized manufacturer

The CE Declaration of Conformity is held on file available to the competent authorities at the following address:

SINAMICS V90 drive

Siemens AG
Digital Factory
Motion Control
Frauenauracher Straße 80
DE-91056 Erlangen
Germany

SIMOTICS S-1FL6 motor

Siemens AG
Digital Factory
Motion Control
Industriestraße 1
DE-97615 Bad Neustadt a. d. Saale
Germany

3 Mounting

3.1 Mounting the drive

Protection against the spread of fire

The device may be operated only in closed housings or in control cabinets with protective covers that are closed, and when all of the protective devices are used. The installation of the device in a metal control cabinet or the protection with another equivalent measure must prevent the spread of fire and emissions outside the control cabinet.

Protection against condensation or electrically conductive contamination

Protect the device, e.g. by installing it in a control cabinet with degree of protection IP54 according to IEC 60529 or NEMA 12. Further measures may be necessary for particularly critical operating conditions.

If condensation or conductive pollution can be excluded at the installation site, a lower degree of control cabinet protection may be permitted.

 WARNING
Death or severe personal injury from harsh installation environment A harsh installation environment will jeopardize personal safety and equipment. Therefore, <ul style="list-style-type: none">• Do not install the drive and the motor in an area subject to inflammables or combustibles, water or corrosion hazards.• Do not install the drive and the motor in an area where it is likely to be exposed to constant vibrations or physical shocks.• Do not keep the drive exposed to strong electro-magnetic interference.

 CAUTION
Risk of injury due to touching hot surfaces There is a risk of injury if you touch the hot surfaces, because surfaces of the drive can reach a high temperature during operation and for a short time after switching-off. <ul style="list-style-type: none">• Avoid coming into direct contact with the drive surface.

For mounting conditions, see Technical data - servo drives (Page 22).

The SINAMICS V90 PN 200 V variant servo drives with rated power of 400 W and 750 W support vertical mounting and horizontal mounting. Other drives support vertical mounting only.

Mount the drive in a shielded cabinet by observing the mounting orientation and clearance specified in the following illustrations.

Mounting orientation

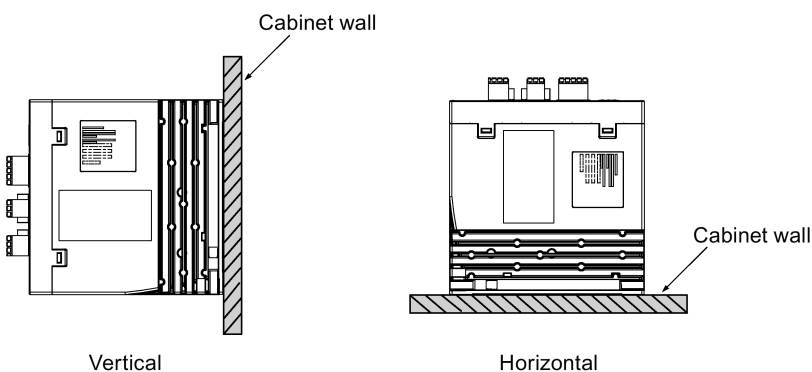

Mounting clearance

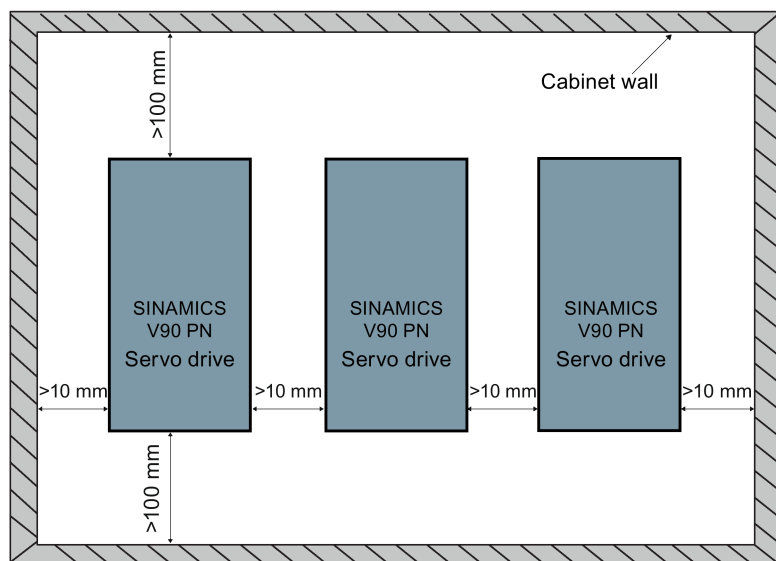

Note

When mounting the drive horizontally, you need to make sure the distance between the drive front panel and the top cabinet wall is longer than 100 mm.

Note

The drive must be derated to 80% when one of the following conditions is satisfied:

- The surrounding temperature is 0 °C to 45 °C, and the mounting clearance is less than 10 mm. In this case, the minimum mounting clearance should not be less than 5 mm.
- The surrounding temperature is 45 °C to 55 °C. In this case, the minimum mounting clearance should not be less than 20 mm.

SINAMICS V90 PN 200V variant (unit: mm)

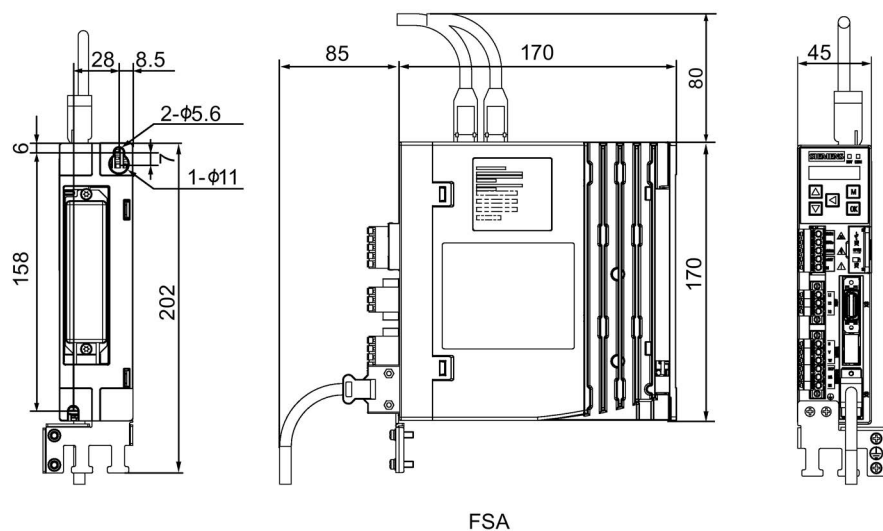

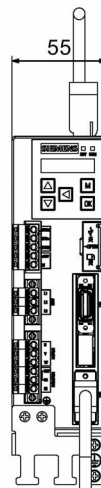
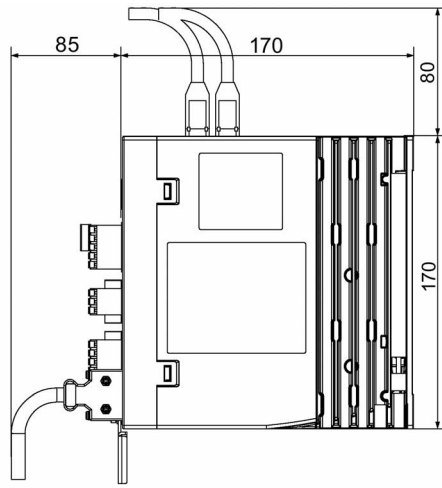
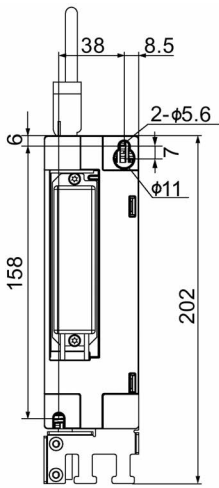

FSB

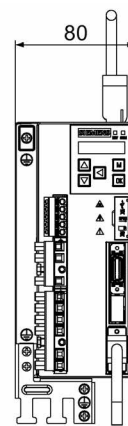
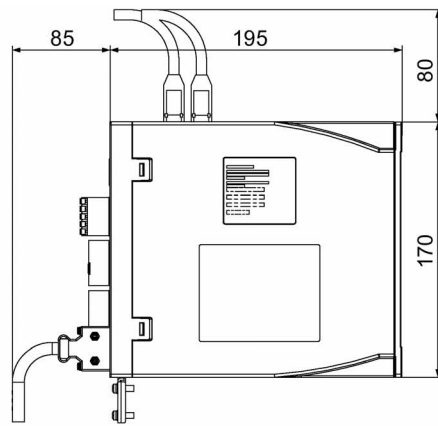
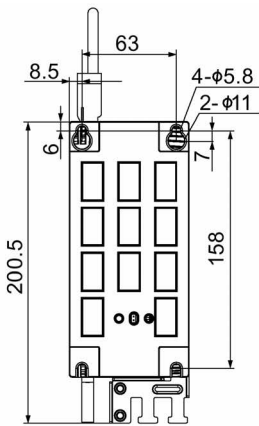

FSC

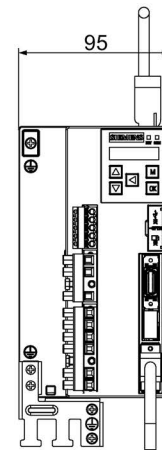
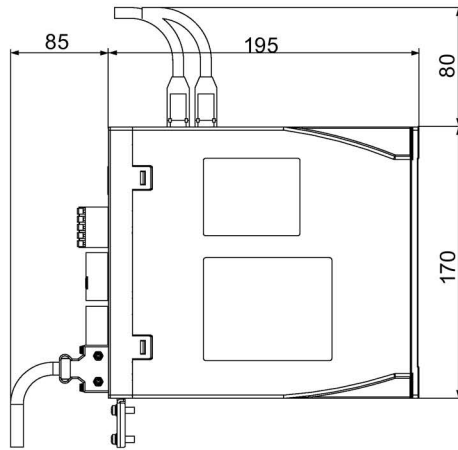
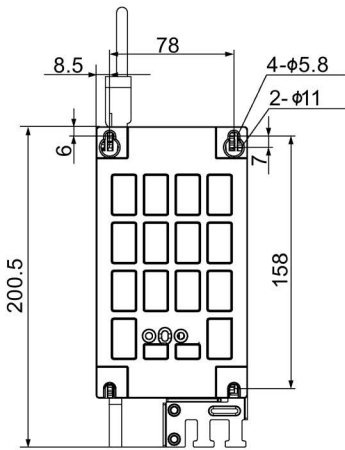

FSD

SINAMICS V90 PN 400V variant (unit: mm)

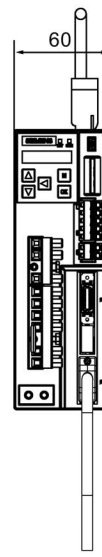
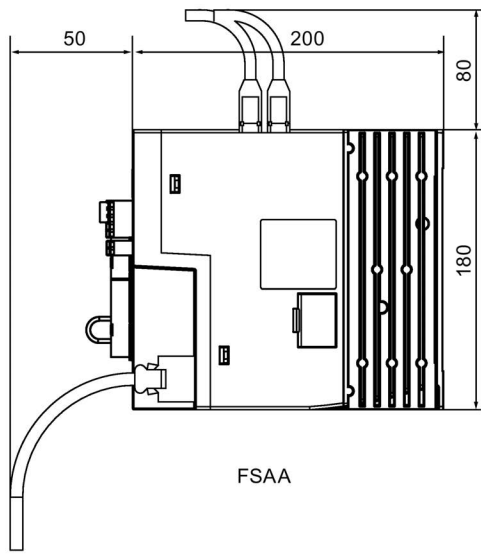
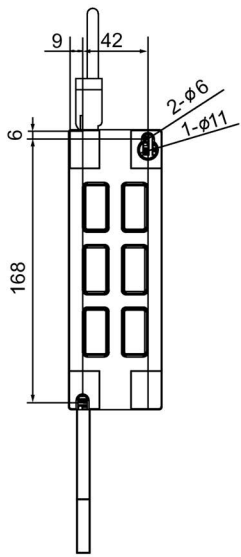

FSA A

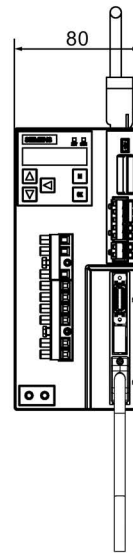
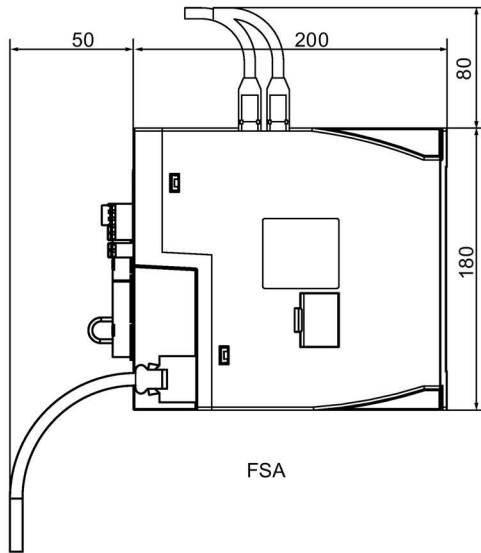
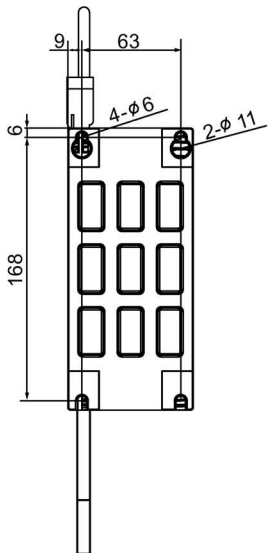

FSA B

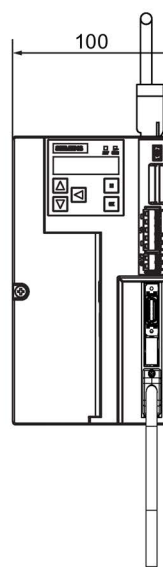
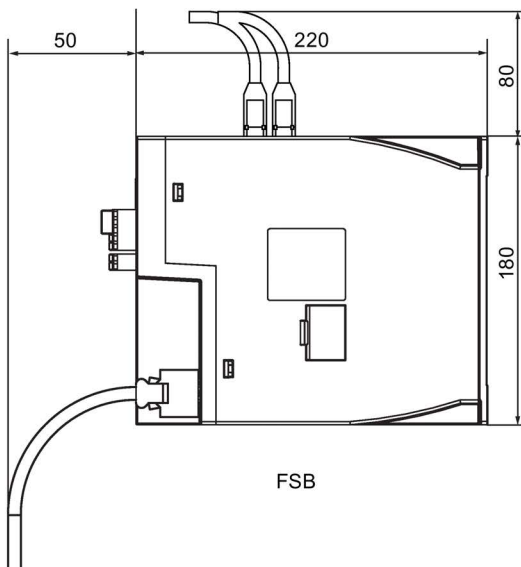
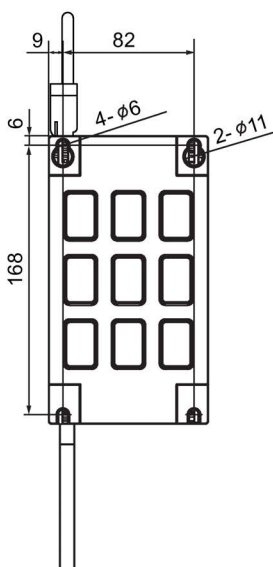

FSB

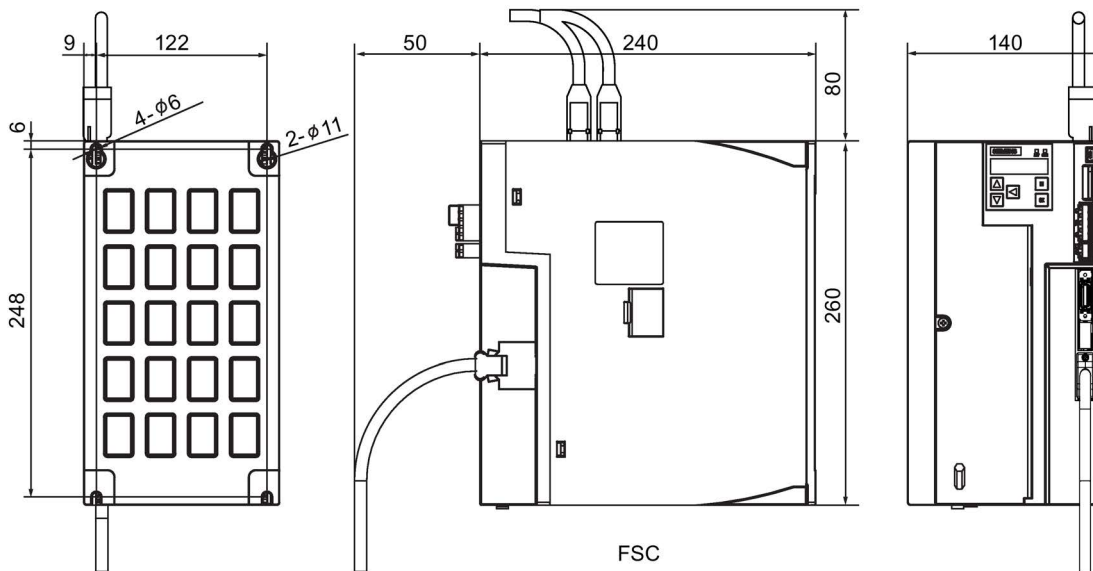

Mounting the drive

For V90 PN 200 V variant, use two M5 screws to mount the FSA and FSB drives and four M5 screws to mount the FSC, and FSD drives.

For V90 PN 400 V variant, use two M5 screws to mount the FSAA drive and four M5 screws to mount the FSA, FSB, and FSC drives.

The recommended tightening torque is 2.0 Nm.

Note

EMC instructions

- To comply with the EMC standards, all cables connected with the SINAMICS V90 PN drive system must be shielded cables, which include cables from the line supply to the line filter and from the line filter to the drive.
- Route signal cables and power cables separately in different cable conduits. The signal cables shall be at least 10 cm away from the power cables.
- The SINAMICS V90 PN drives have been tested in accordance with the emission requirements of the category of C2 (domestic) environment. The conductive emissions and radiated emissions are in compliance with the standard of EN 55011 and reached Class A.
- In a residential environment, this product can cause high-frequency interferences that may necessitate suppression measures.
- For a radiated emission test, an external AC filter (between the mains supply and the drive) will be used to meet the EMC requirement and the drive will be installed inside the shielded metallic chamber, other parts of the motion control system (including the PLC, DC power supply, motor) will be put inside the shielded chamber.
- For a conductive emission test, an external AC filter (between the mains supply and the drive) will be used to meet the EMC requirement.
- For the radiated emission and conductive emission test, the length of the line supply cable between the line filter and the drive must be shorter than 1 m.
- The harmonic current value of SINAMICS V90 PN drive exceeds the class A limit of IEC 61000-3-2, but the SINAMICS V90 PN drive system installed within the Category C2 First Environment require supply authority acceptance for connection to the public low-voltage power supply network. Please contact your local supply network provider.

Note

Screw tightening

Make sure you fix the screw to the terminal door of the drive after you have completed the installation work.

3.2 Mounting the motor

NOTICE

Damage to the encoder due to shocking

Shocks at the motor shaft end can cause an encoder damage.



- Do not exert any shock at the shaft end.

For mounting conditions, see Technical data - servo motors (Page 25).

Mounting orientation

SIMOTICS S-1FL6 supports flange mounting only and three types of constructions, so it can be installed in three orientations as shown in the following figure.

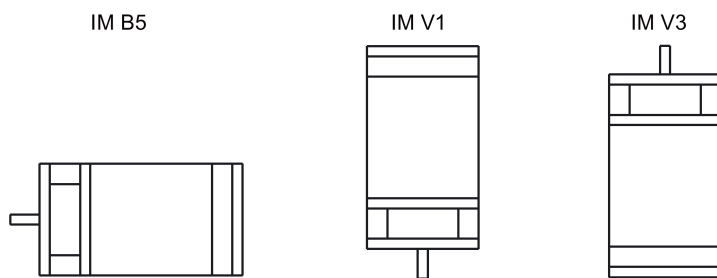

Note

When configuring the IM V3 type of construction, pay particular attention to the permissible axial force (weight force of the drive elements) and the necessary degree of protection.

Motor dimensions (unit: mm)

Low inertia servo motor, shaft height: 20 mm, 30 mm, and 40 mm

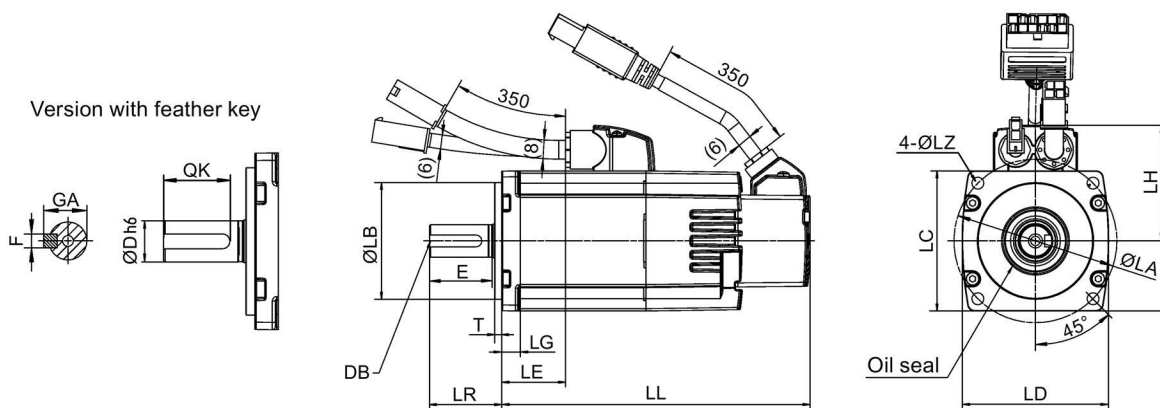

Low inertia servo motor, shaft height: 50 mm, with straight connectors

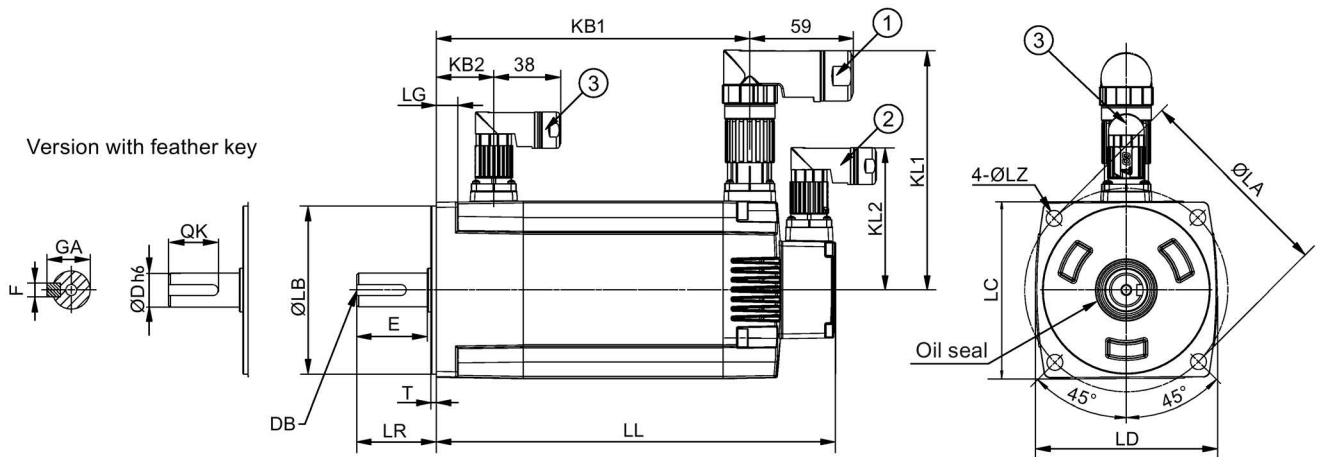

Low inertia servo motor, shaft height: 50 mm, with angular connectors

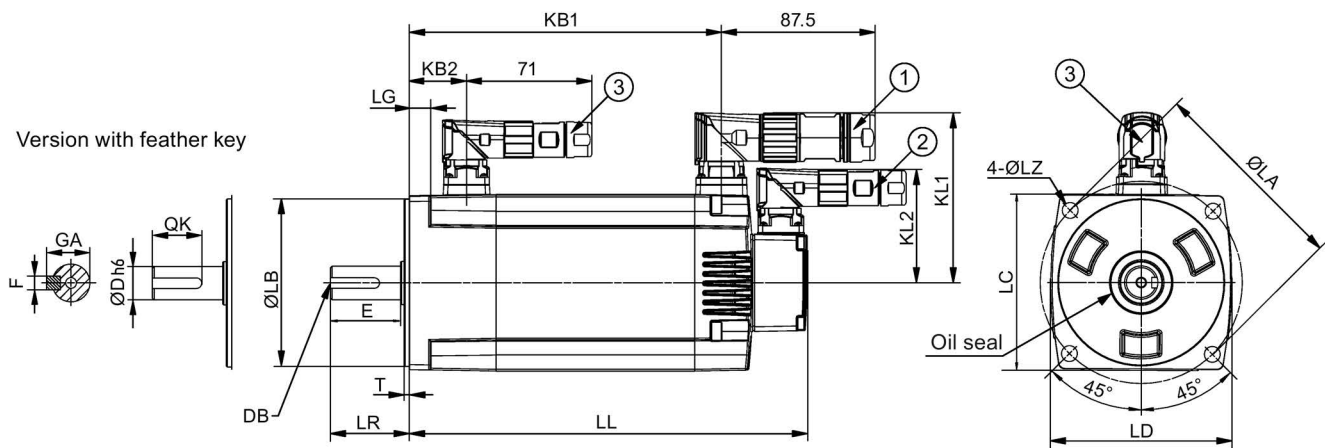

Type	1FL60...	22	24	32	34	42	44	52	54
Shaft height		20		30		40		50	
LC		40		60		80		100	
LD		42		63		82.6		103	
LA		46		70		90		115	
LZ		4.5		5.5		7		9	
LB		30 - 0.02		50 - 0.03		70 - 0.03		95 - 0.03	
LH		40		50		60		-	
LE		15	35	27	52	40	60	-	
LR		25		31		35		45	
T		2.5 - 0.2		3 - 0.2		3 - 0.3		3 - 0.3	
LG		6		8		8		12	
D		8 - 0.009		14 - 0.011		19 - 0.013		19 - 0.013	
DB		M3 × 8		M4 × 15		M6 × 16		M6 × 16	
E		22		26		30		40	
QK		17.5		22.5		28		28	
GA		9.2		16		21.5		21.5	
F		3		5		6		6	

Type	1FL60...	22	24	32	34	42	44	52	54
Without brake	LL	86	106	98	123	139	158.8	192	216
	KB1	-	-	-	-	-	-	143.5	167.5
With brake	LL	119	139	132.5	157.5	178.3	198.1	226	250
	KB1	-	-	-	-	-	-	177.5	201.5
	KB2	-	-	-	-	-	-	32.5	32.5
KL1	-	-	-	-	-	-	-	135	135
KL2	-	-	-	-	-	-	-	80	80

- ①–Power cable connector, ②–Incremental/absolute encoder cable connector, ③–Brake cable connector. These connectors should be ordered separately. For more information about the order information of the connectors, see the SINAMICS V90, SIMOTICS S-1FL6 Operating Instructions.
- For the low inertia motor with shaft-height of 50 mm, the boundary dimensions of encoder connector–② and brake connector–③ are the same.
- For the low inertia motor with shaft-height of 20 mm, only two screws are needed to mount the flange.

High inertia servo motor with straight connectors, with the incremental encoder

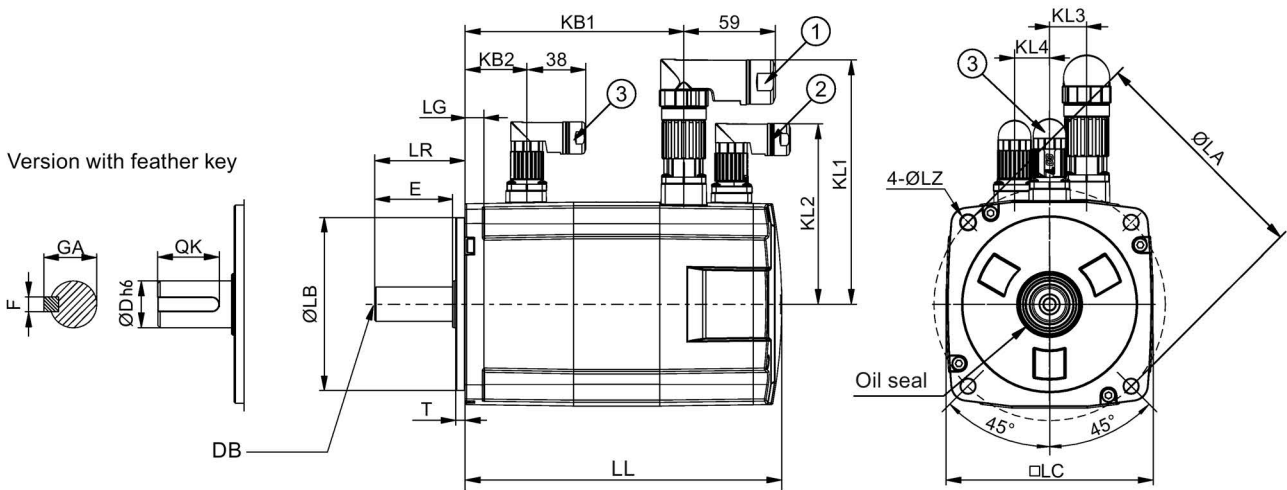

High inertia servo motor with angular connectors, with the incremental encoder

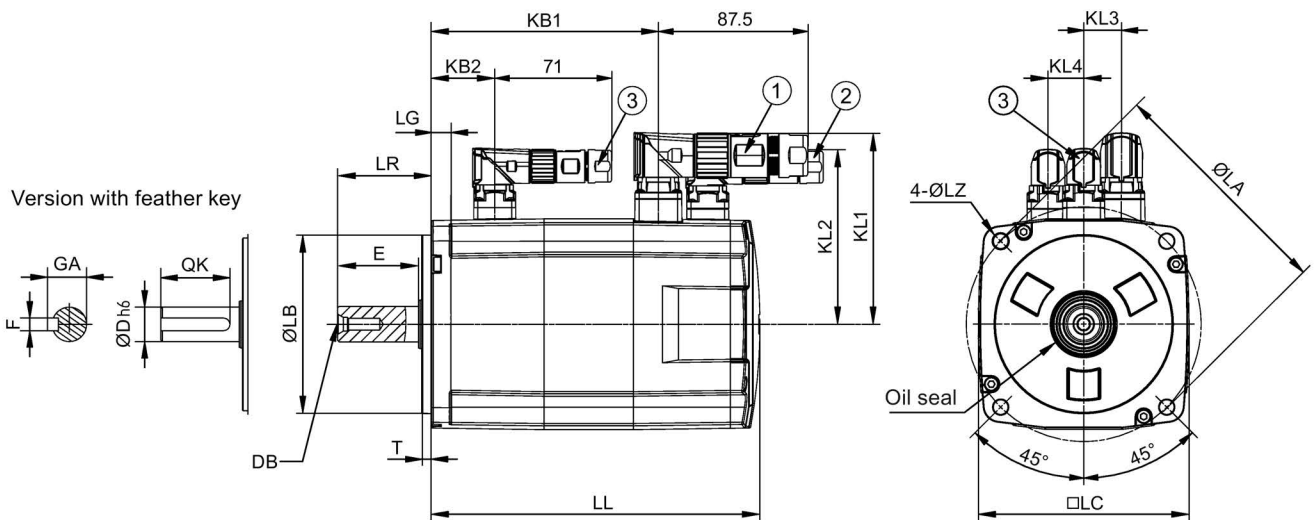

Type	1FL60...	42	44	61	62	64	66	67	90	92	94	96
Shaft height		45		65				90				
LC		90		130				180				
LA		100		145				200				
LZ		7		9				13.5				
LB		80 - 0.03		110 - 0.035				114.3 - 0.035				
LR		35		58				80				
T		4 - 0.3		6 - 0.3				3 - 0.3				
LG		10		12				18				
D		19 - 0.013		22 - 0.013				35 - 0.016				
DB		M6 x 16		M8 x 16				M12 x 25				
E		30		50				75				
QK		25		44				60				
GA		21.5		25				38				
F		6 - 0.03		8 - 0.036				10 - 0.036				
Without brake	LL	154.5	201.5	148	181/16 4.5 ¹⁾	181	214	247	189.5	211.5	237.5	289.5
	KB1	93.5	140.5	85.5	118.5	118.5	151.5	184.5	140	162	188	240
	KB2	-		-				-				
With brake	LL	201	248	202.5	235.5/ 219 ¹⁾	235.5	268.5	301.5	255	281	307	359
	KB1	140	187	140	173	173	206	239	206	232	258	310
	KB2	31.5		39.5				44.5				
With straight connectors	KL1	136		158				184				
	KL2	92		115				149				
	KL3	13		23				34				
	KL4	14		22				34				
With angular connectors	KL1	96.2		117.5				143				
	KL2	84.6		108				141.1				
	KL3	13		23				34				
	KL4	14		22				34				
<ul style="list-style-type: none"> ① – Power cable connector, ② – Incremental encoder cable connector, ③ – Brake cable connector. These connectors should be ordered separately. For more information about the order information of the connectors, see the SINAMICS V90, SIMOTICS S-1FL6 Operating Instructions. The boundary dimensions of encoder connector–② and brake connector–③ are the same. The shaft height 90 mm motor has two M8 screw holes for eyebolts. 												

¹⁾ The former value indicates the dimension for high inertia motors with straight connectors; the latter value indicates the dimension for high inertia motors with angular connectors.

High inertia servo motor with straight connectors, with the absolute encoder

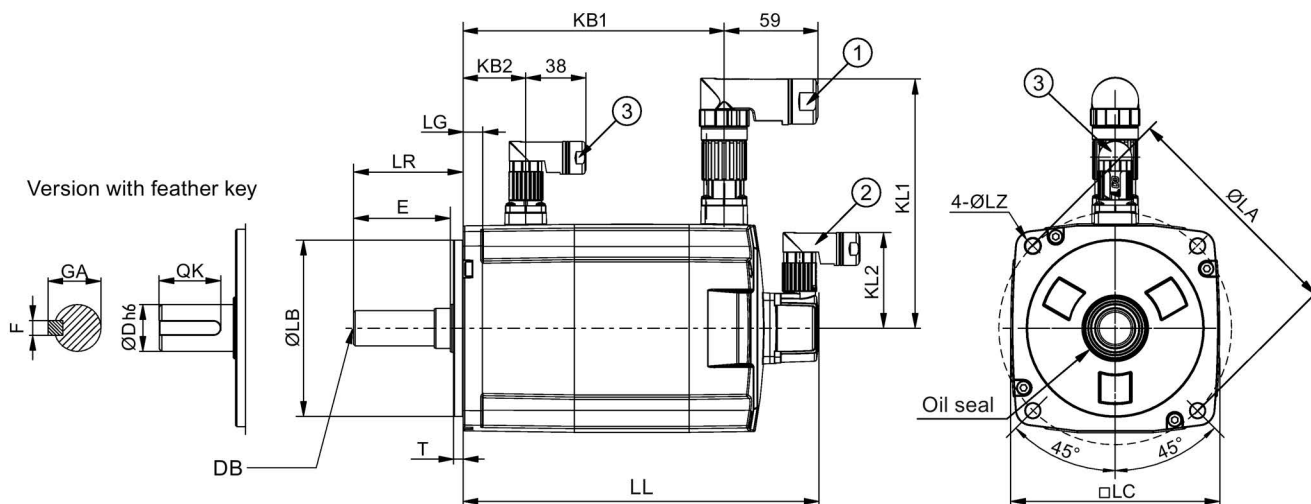

High inertia servo motor with angular connectors, with the absolute encoder

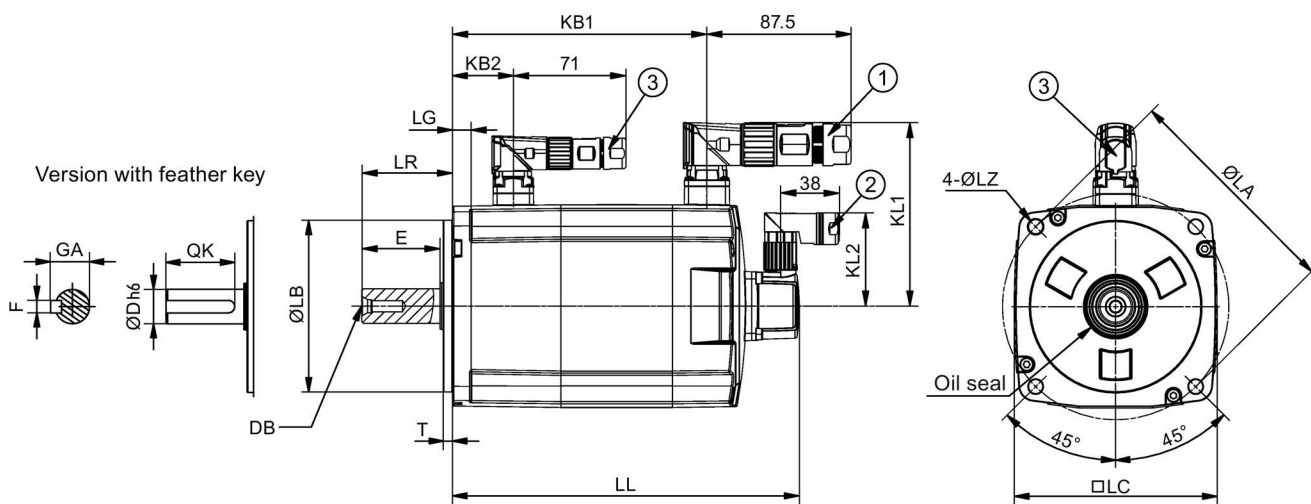

Type	1FL60...	42	44	61	62	64	66	67	90	92	94	96
Shaft height		45		65					90			
LC		90		130					180			
LA		100		145					200			
LZ		7		9					13.5			
LB		80 - 0.03		110 - 0.035					114.3 - 0.035			
LR		35		58					80			
T		4 - 0.3		6 - 0.3					3 - 0.3			
LG		10		12					18			
D		19 - 0.013		22 - 0.013					35 - 0.016			
DB		M6 x 16		M8 x 16					M12 x 25			
E		30		50					75			
QK		25		44					60			
GA		21.5		25					38			
F		6 - 0.03		8 - 0.036					10 - 0.036			

Type	1FL60...	42	44	61	62	64	66	67	90	92	94	96
Without brake	LL	157	204	151	184/167.5 ¹⁾	184	217	250	197	223	249	301
	KB1	100	147	92	125	125	158	191	135	161	187	239
	KB2	-			-				-			
With brake	LL	203.5	250.5	205.5	238.5/222 ¹⁾	238.5	271.5	304.5	263	289	315	367
	KB1	147	194	147	180	180	213	246	201	227	253	305
	KB2	31.5		39.5				44.5				
With straight connectors	KL1	136		158				184				
	KL2	60		60				60				
With angular connectors	KL1	96.2		117.5				143				
	KL2	60		60				60				

- ①-Power cable connector, ②-Absolute encoder cable connector, ③-Brake cable connector. These connectors should be ordered separately. For more information about the order information of the connectors, see the SINAMICS V90, SIMOTICS S-1FL6 Operating Instructions.
- The shaft height 90 mm motor has two M8 screw holes for eyebolts.

¹⁾ The former value indicates the dimension for high inertia motors with straight connectors; the latter value indicates the dimension for high inertia motors with angular connectors.

Mounting the motor

 WARNING
Personal injury and material damage due to motor falling down
Some motors, especially the 1FL609□ are heavy. Motor falling down can cause serious personal injury or material damage.
<ul style="list-style-type: none"> • The excessive weight of the motor should be considered and any necessary assistance required for mounting should be sought.

NOTICE
Damage to the motor due to liquid entering
If the liquid enters the motor, the motor may be damaged
<ul style="list-style-type: none"> • During motor installation or operation, make sure that no liquid (water, oil, etc.) can penetrate into the motor. • When installing the motor horizontally, make sure that the cable outlet faces downward to protect the motor from ingress of oil or water.

NOTICE
Damage to the absolute encoder due to the magnetic interference from the magnetic field
The magnetic interference from the magnetic field can cause a damage to the absolute encoder.
<ul style="list-style-type: none"> • To avoid magnetic interference to the absolute encoder, keep the servo motor with an absolute encoder at least 15 mm away from the devices that produce a magnetic field stronger than 10 mT.

Note

Using the eyebolts

The 1FL609□ motor (90 mm shaft height) has two M8 screw holes for screwing in two eyebolts. Lift the 1FL609□ motor only at the eyebolts.

Eyebolts that have been screwed in must be either tightened or removed after mounting.

Install the motor onto a steel flange with four screws as shown in the following figure:

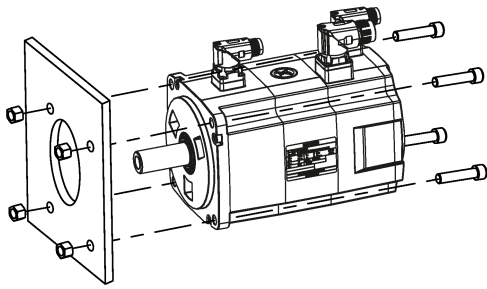

Motor	Screw	Recommended flange size	Tightening torque	Flange material
Low inertia motors				
1FL602□	2 x M4	120 x 100 x 40 (mm)	2.4 Nm	Steel
1FL603□	4 x M5	120 x 100 x 40 (mm)	4.7 Nm	
1FL604□	4 x M6	120 x 100 x 40 (mm)	8 Nm	
1FL605□	4 x M8	120 x 100 x 40 (mm)	20 Nm	
High inertia motors				
1FL604□	4 x M6	270 x 270 x 10 (mm)	8 Nm	Steel
1FL606□	4 x M8	390 x 390 x 15 (mm)	20 Nm	
1FL609□	4 x M12	420 x 420 x 20 (mm)	85 Nm	

Motor heating conditions

The rated motor specifications are continuous allowable values at a surrounding air temperature of 40 °C when the motor is installed with a steel flange. When the motor is mounted on a small surface, the motor temperature may rise considerably because of the limited heat radiating abilities of the surface. Make sure you use a suitable flange according to Siemens recommended flange sizes.

Note

The actual temperature rise depends on how the flange (motor mounting section) is fixed on the installation surface, what material is used for the motor mounting section, and motor speed. Always check the actual motor temperature.

4 Connecting

4.1 System connection

The following illustrations show the examples of the SINAMICS V90 PN servo system connection.

Connection diagram for FSB on the single phase power network:

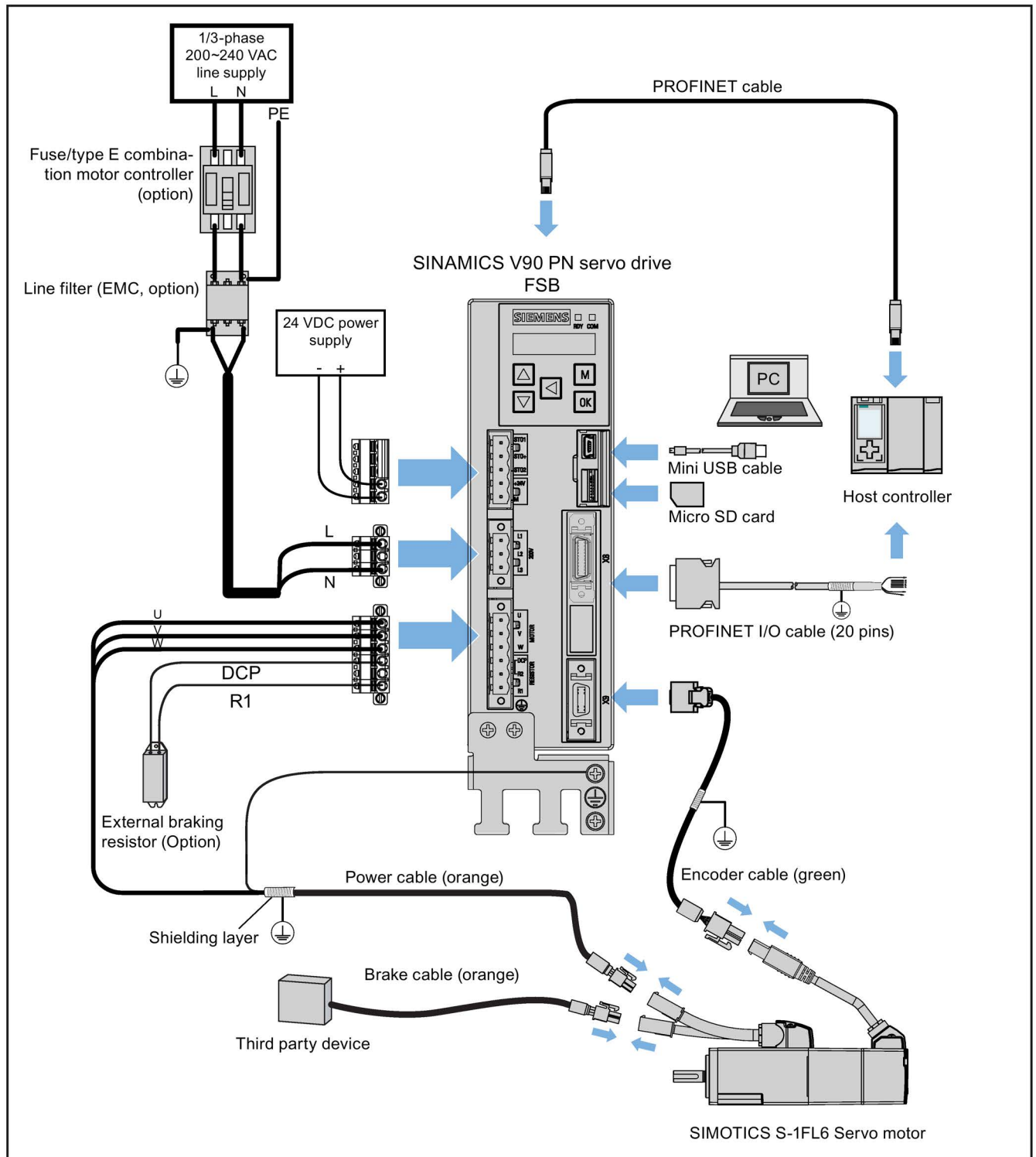

Connection diagram for FSD on the three phase power network:

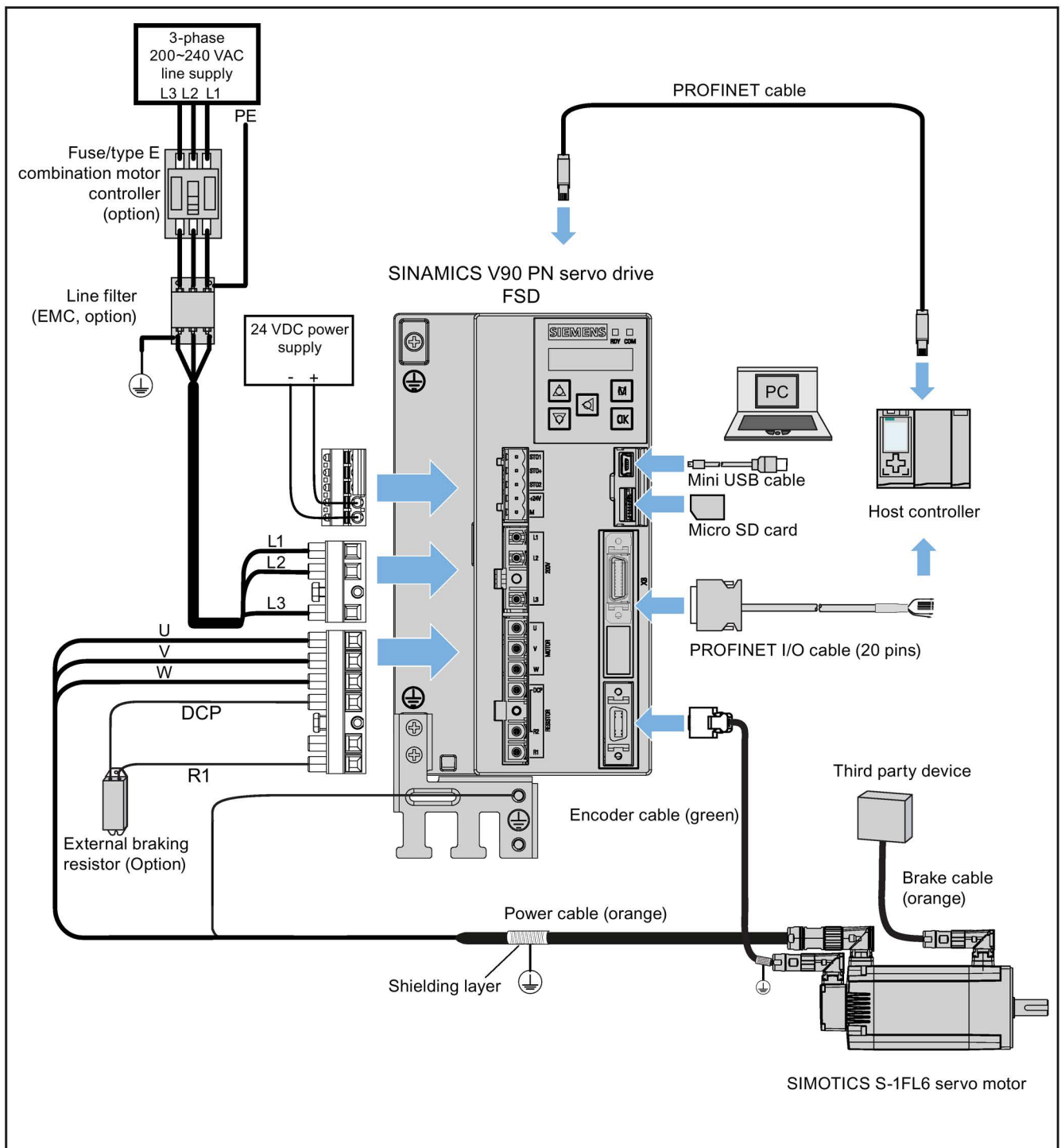



⚠ DANGER

Danger to life when PE connectors are touched
When the equipment is working, hazardous touch current can be present at the PE connectors; if touched, this can result in death or severe personal injury.

- Do not touch the PE connector during operation or within a certain period since power disconnection.



⚠ WARNING

Personal injury and damage to property from improper connections
Improper connections have high risks of electrical shock and short circuit, which will jeopardize personal safety and equipment.

- The drive must be directly connected with the motor. It is not permissible to connect a capacitor, inductor or filter between them.
- The line supply voltage must be within the allowable range (refer to the drive rating plate). Never connect the line supply cable to the motor terminals U, V, W or connect the motor power cable to the line input terminals L1, L2, L3.
- Never wire up the U, V, W terminals in an interchanged phase sequence.
- If the CE marking for cables is mandatory in some cases, the motor power cable, line supply cable and brake cable used must all be shielded cables.
- For terminal connection, make sure that the clearances in air between non-insulated live parts are at least 5.5 mm.
- Cables connected may not come into contact with rotating mechanical parts.

⚠ CAUTION

Personal injury and damage to property from inadequate protection
Inadequate protection may cause minor personal injury or damage to property.

- Route a second PE conductor with the cross section of the supply system lead in parallel to the protective earth via separate terminals or use a copper protective earth conductor with a cross section of 10 mm².
- Terminals for equipotential bondings that exist in addition to terminals for PE conductors must not be used for looping-through the PE conductors.
- To ensure protective separation, an isolating transformer must be used for the 220 VAC/380 VAC line supply system.

NOTICE

Drive damage caused by short-circuiting between the shielding wire and the unused pin on the setpoint connector
The shielding wire may inadvertently be short-circuited to the unused pin on the to-be-assembled setpoint connector. This can cause damage to the drive.

- Exercise caution when connecting the shielding cable to the setpoint connector.
- For more information about the assembly method of the connector, see Section "Assembly of cable terminals on the drive side" in the SINAMICS V90, SIMOTICS S-1FL6 Operating Instructions.

Note

Failure to meet the EMC requirements resulting from failure to observe the wiring instruction
Failure to meet the EMC requirements because you do not observe the wiring instruction.

- In order to meet **EMC** requirements, all cables must be shielded cables.
- Make sure that you connect the cable shields of shielded twisted-pair cables to the shielding plate or the hose clamp of the servo drive.

Note

Low Voltage Directive complied
Our products comply with EN61800-5-1: 2007 standards and Low Voltage Directive (Low Voltage Directive 2006/95/EC).

Note

For low inertia motors of shaft heights 20 mm, 30 mm and 40 mm, the encoder cable connectors may only be accessible to electrically skilled personnel.

Note

The mini-USB interface of the SINAMICS V90 PN is used for fast commissioning and diagnostics with SINAMICS V-ASSISTANT installed in the PC. Do not use it for long monitoring.

Connecting the cable shields with the shielding plate

To achieve EMC-compliant installation of the drive, use the shielding plate that is shipped with the drive to connect the cable shields. See the following example for steps of connecting cable shields with the shielding plate:

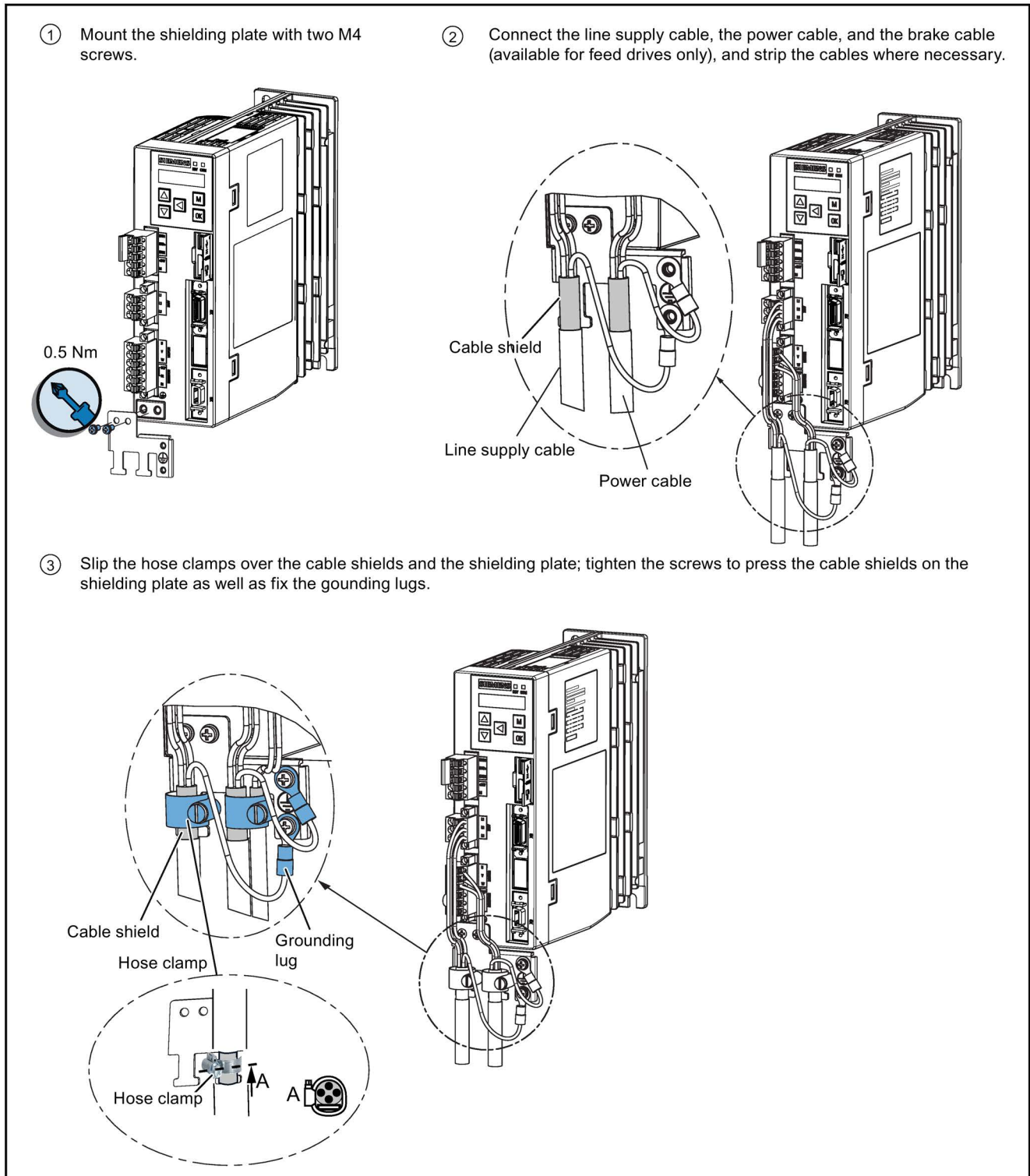



⚠ WARNING

Risk of electric shock and fire from a network with an excessively high impedance

Excessively low short-circuit currents can lead to the protective devices not tripping or tripping too late, and so causing electric shock or a fire.

- In the case of a conductor-conductor or conductor-ground short-circuit, ensure that the short-circuit current at the point where the drive is connected to the line supply at least meets the minimum requirements for the response of the protective device used.
- You must use an additional residual-current device (RCD) if a conductor-ground short circuit does not reach the short-circuit current required for the protective device to respond. The required short-circuit current can be too low, especially for TT systems.



⚠ WARNING

Risk of electric shock and fire from a network with an impedance that is too low

Excessively high short-circuit currents can lead to the protective devices not being able to interrupt these short-circuit currents and being destroyed, and so causing electric shock or a fire.

- Ensure that the uninfluenced short-circuit current at the line terminal of the drive does not exceed the breaking capacity (SCCR or I_{cc}) of the protective device used.



⚠ WARNING

Death or severe personal injury from electrical shock

The earth leakage current for the drive can be greater than AC 3.5 mA, which may cause death or severe personal injury due to electrical shock.

- A fixed earth connection is required to eliminate the dangerous leakage current. In addition, the minimum size of the protective earth conductor shall comply with the local safety regulations for high leakage current equipment.

Adjusting cable directions from the motor side

For some low inertia motors and all high inertia motors, you can adjust the direction of the power cable, encoder cable, or brake cable from the motor side to facilitate cable connection.

The following illustrations take high inertia motors with the incremental encoder for example to show how to adjust the cable directions.

Low inertia motors with a shaft height of 50 mm and high inertia motors with straight connectors

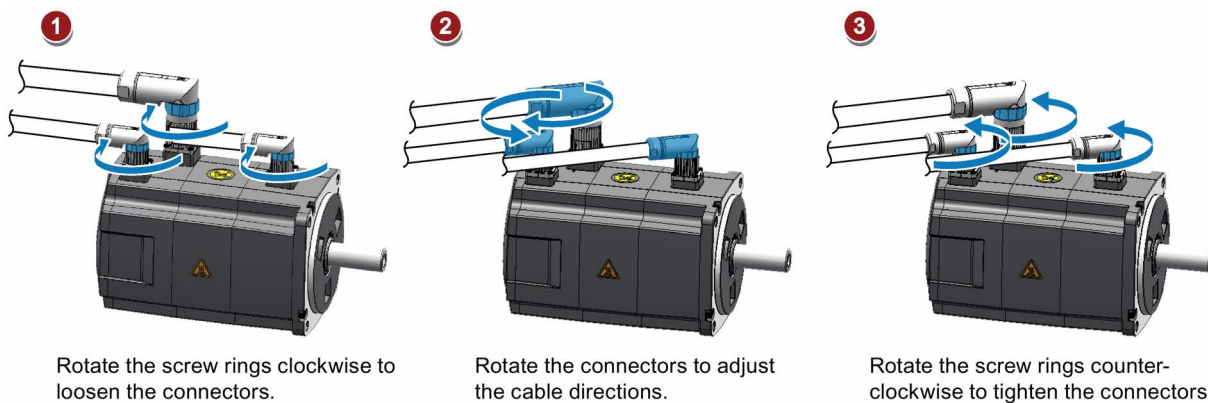

Note

Rotating the connectors

You can rotate all the three motor-side connectors only within 360°.

High inertia motors with angular connectors

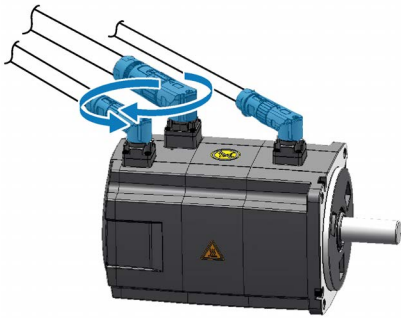

Rotate the connectors to adjust the cable directions.

Note

Rotating the connectors

You can rotate all the three motor-side connectors only within 310°.

Note

For an absolute encoder cable on a high inertia motor with angular connectors, adjust its direction just the same as you adjust the cable directions on a high inertia motor with straight connectors mentioned above.

4.2 Main circuit wiring

4.2.1 Line supply - L1, L2, L3

SINAMICS V90 PN 200 V variant

Recommended minimum cable cross-section:

When used on the single phase power network:

FSA: 0.33 mm²

FSB: 0.52 mm²

FSC: 1.31 mm²

When used on the three phase power network:

FSA and FSB: 0.33 mm²

FSC: 0.52 mm²

FSD (1 kW): 0.82 mm²

FSD (1.5 kW to 2 kW): 2.08 mm²

SINAMICS V90 PN 400 V variant

Recommended minimum cable cross-section:

FSAA and FSA: 1.5 mm²

FSB and FSC: 2.5 mm²

Note

For 200 V variant, when using the FSA, FSB and FSC on the single phase power network, you can connect the power supply to any two connectors of L1, L2, and L3.

Assembling the line supply cable terminals

The procedure of assembling a line supply cable terminal is the same as that for a power cable terminal on the drive side. For more information, see the SINAMICS V90, SIMOTICS S-1FL6 Operating Instructions.

Attaching the line supply cable

⚠ CAUTION
Risk of injury due to improper cable connection
When attaching the line supply cable to a line supply connector that has not been fixed on the drive, you can injure your fingers.
<ul style="list-style-type: none">• Make sure you first fix the line supply connector on the drive, and then attach the cable to the connector.

200 V variant

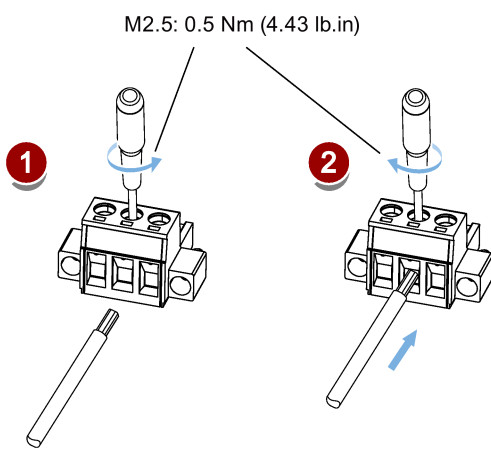

400 V variant

- For FSAA and FSA

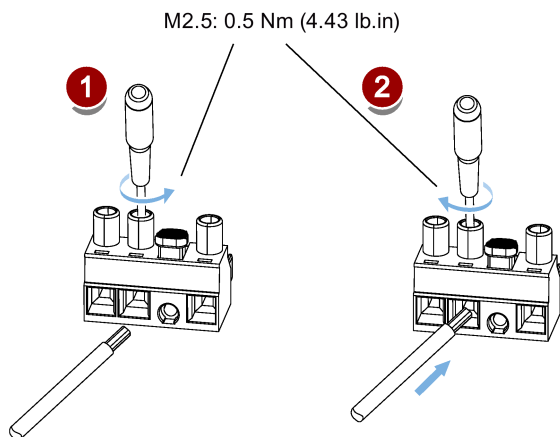

- For FSB and FSC

The FSB and FSC servo drives are equipped with barrier terminals for line supply connection. You can fix the line supply cable on the servo drives by using the M4 screws with a tightening torque of 2.25 Nm (19.91 lb.in).

4.2.2 Motor power - U, V, W

Motor output - drive side

SINAMICS V90 PN 200 V variant

Recommended minimum cable cross-section:

FSA and FSB: 0.75 mm²

FSC and FSD (1 kW): 0.75 mm²

FSD (1.5 kW to 2 kW): 2.5 mm²

SINAMICS V90 PN 400 V variant

Recommended minimum cable cross-section:

FSAA and FSA: 1.5 mm²

FSB and FSC: 2.5 mm²

Wiring

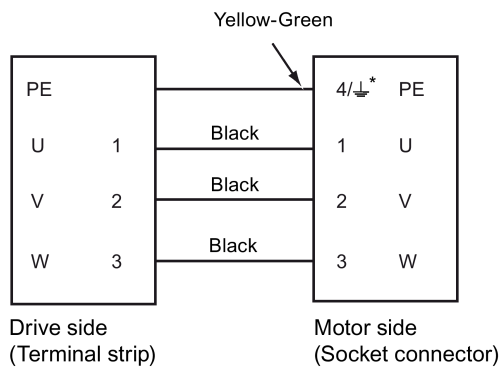

- * 4: high inertia motors with straight connectors and all low inertia motors
 ⌵: high inertia motors with angular connectors

Attaching the motor power cable

⚠ CAUTION

Risk of injury due to improper cable connection

When attaching the motor power cable to a motor power connector that has not been fixed on the drive, you can injure your fingers.

- Make sure you first fix the motor power connector on the drive, and then attach the cable to the connector.

200 V variant

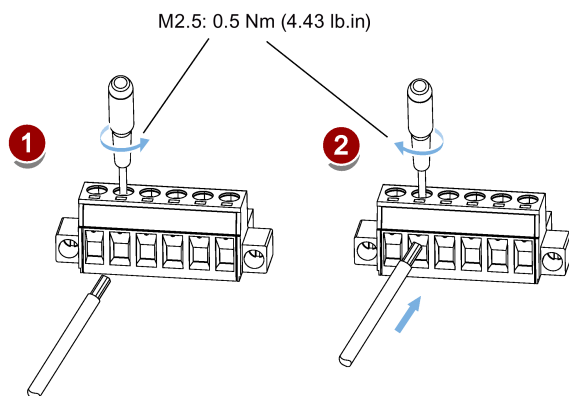

400 V variant

- For FSAA and FSA

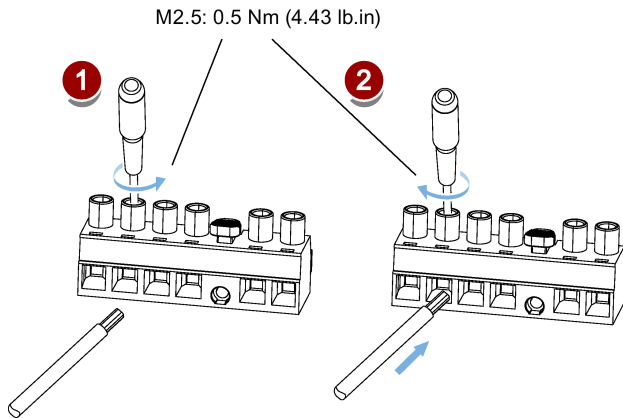

- For FSB and FSC

The FSB and FSC servo drives are equipped with barrier terminals for motor power connection. You can fix the motor power cable on the servo drives by using the M4 screws with a tightening torque of 2.25 Nm (19.91 lb.in).

4.3 Control/Status interface - X8

4.3.1 Interface definition

Pin	Signal	Description	Pin	Signal	Description
<p>Type: 20-pin MDR socket</p>					
Digital inputs/outputs					
1	DI1	Digital input 1	11	DO1+	Digital output 1, positive
2	DI2	Digital input 2	12	DO1-	Digital output 1, negative
3	DI3	Digital input 3	13	DO2+	Digital output 2, positive
4	DI4	Digital input 4	14	DO2-	Digital output 2, negative
6	DI_COM	Common terminal for digital inputs	17 *	BK+	Motor holding brake control signal, positive
7	DI_COM	Common terminal for digital inputs	18 *	BK-	Motor holding brake control signal, negative
None					
5	-	Reserved	15	-	Reserved
8	-	Reserved	16	-	Reserved
9	-	Reserved	19	-	Reserved
10	-	Reserved	20	-	Reserved

* The pins are used to connect the brake control signals for 200 V variant drive only.

4.3.2 Standard wiring

Example 1

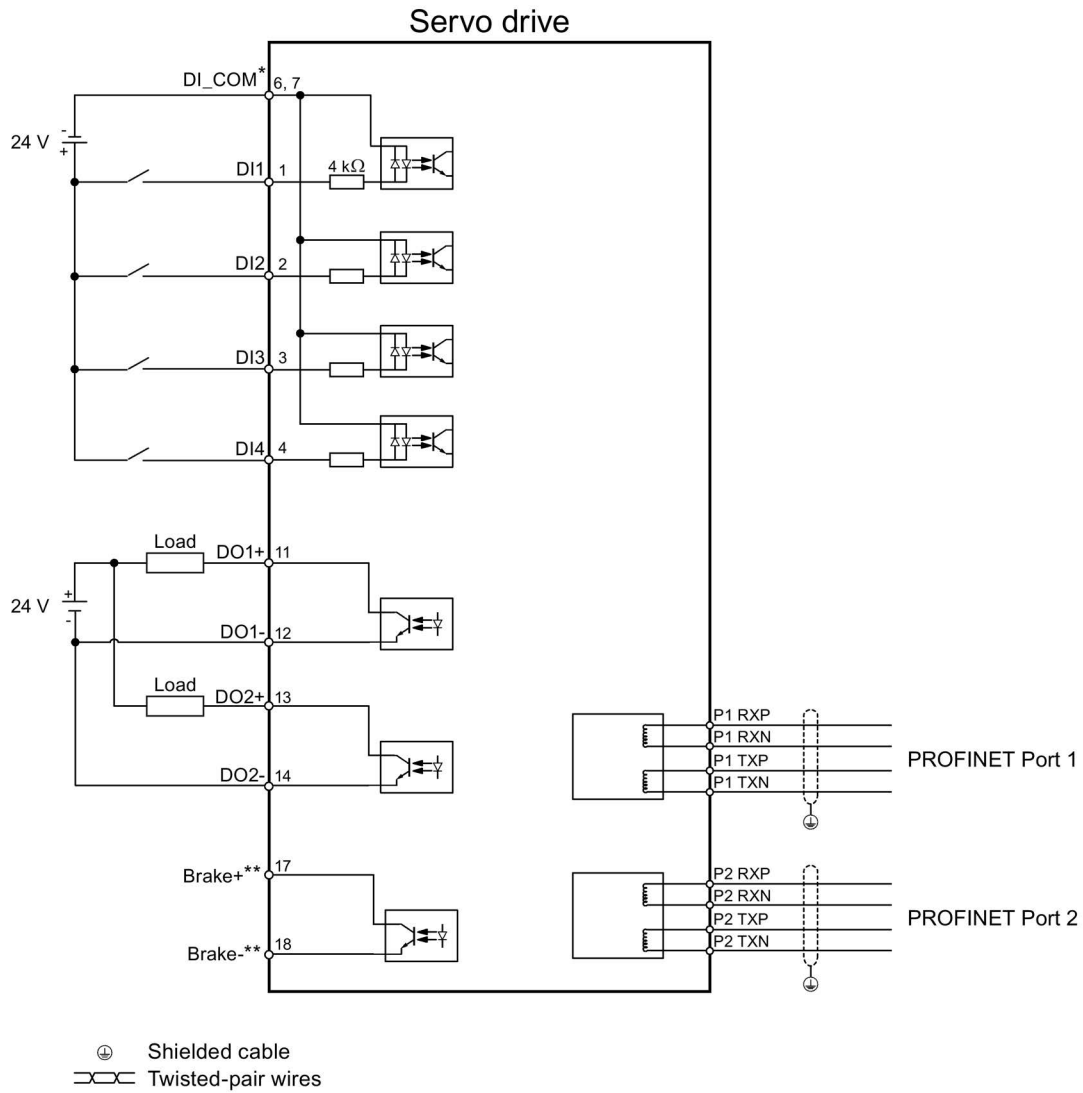

Example 2

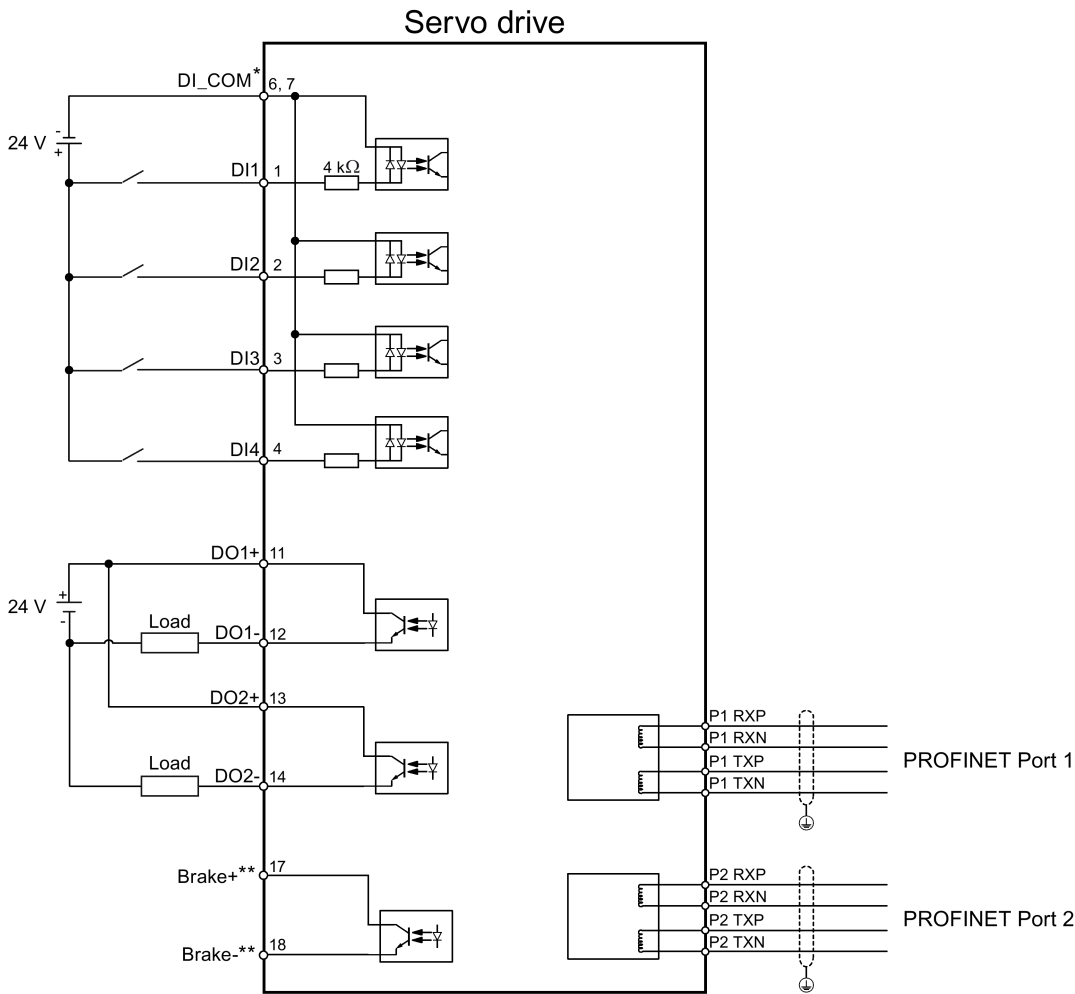

⊕ Shielded cable

⊗ Twisted-pair wires

* Digital inputs, supporting both PNP and NPN types.

** The pins are used to connect the brake control signals for 200 V variant drive only. Refer to the section "Motor holding brake" in SINAMICS V90, SIMOTICS S-1FL6 Operating Instructions for the detailed connections.

4.4 24 V power supply/STO

The pin assignment for the 24 V power supply/STO interface is shown as follows:

Interface	Signal name	Description
	STO 1	Safe torque off channel 1
	STO +	Specific power supply for safe torque off
	STO 2	Safe torque off channel 2
	+24 V	Power supply, 24 VDC
	M	Power supply, 0 VDC
	Maximum conductor cross-section: 1.5 mm ²	

Wiring

⚠ WARNING

Material damages and personal injuries by the drop of a hanging axis

When the servo system is used as a hanging axis, the axis will drop if the positive and negative poles of the 24 V power supply are connected inversely. Unexpected drop of the hanging axis can cause material damages and personal injuries.

- Make sure that the 24 V power supply is correctly connected.

⚠ WARNING

Material damages and personal injuries by the drop of a hanging axis

Unexpected drop of the hanging axis can cause material damages and personal injuries.

- It is not allowed to use the STO with a hanging axis because the axis may drop.

Note

Using the STO function

The STO1, STO+ and STO2 are short connected at the factory setting.

When the STO function is to be used, you must remove the short-circuit stick before connecting the STO interfaces. The safety function of the servo drive is SIL 2 (EN61800-5-2). If you do not need to use it any more, you must reinsert the short-circuit stick; otherwise, the motor will not run.

For detailed information about the STO function, refer to chapter "Safety Integrated basic functions" of SINAMICS V90, SIMOTICS S-1FL6 Operating Instructions.

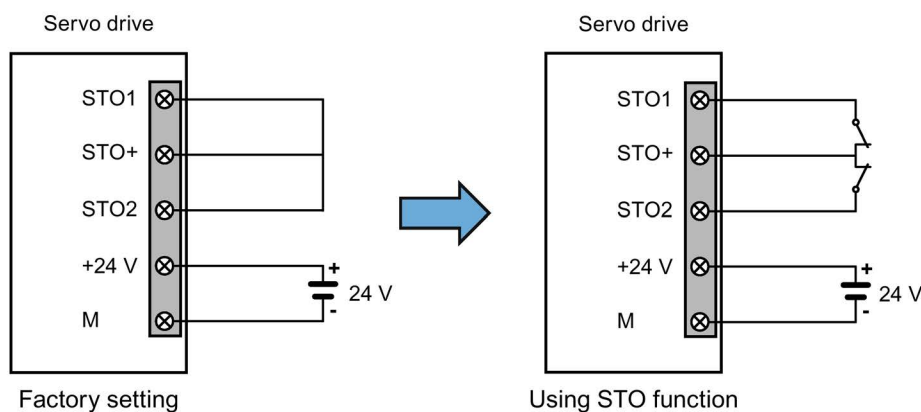

Assembling the 24 V power supply and STO cable terminals

The procedure of assembling a 24 V power cable terminal or an STO cable terminal is the same as that for a power cable terminal on the drive side of the V90 PN 200 V servo drives.

For more information, see the SINAMICS V90, SIMOTICS S-1FL6 Operating Instructions.

Plugging the 24 V power supply and STO cables

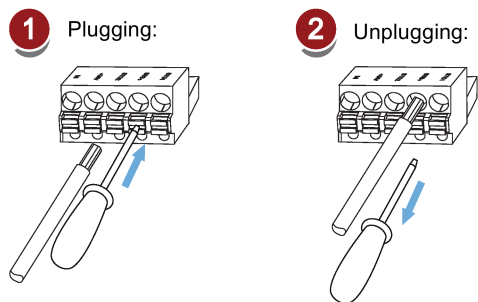

4.5 Encoder interface - X9

The SINAMICS V90 PN 200V variant servo drive supports two kinds of encoders:

- Incremental encoder TTL 2500 ppr
- Absolute encoder single-turn 21-bit

The SINAMICS V90 PN 400V variant servo drive supports two kinds of encoders:

- Incremental encoder TTL 2500 ppr
- Absolute encoder 20-bit + 12-bit multi-turn

NOTICE
<p>Drive damage caused by short-circuiting between the shielding wire and the unused pin on the encoder connector</p> <p>The shielding wire may inadvertently be short-circuited to the unused pin on the to-be-assembled encoder connector. This can cause damage to the drive.</p> <ul style="list-style-type: none"> • Exercise caution when connecting the shielding cable to the encoder connector. • For more information, see Section "Assembly of cable terminals on the drive side" in the SINAMICS V90, SIMOTICS S-1FL6 Operating Instructions.

Note

Failure to meet the EMC requirements because the cable is not shielded

If a cable is not shielded, it can not meet the EMC requirements.

- The encoder cable **must** be shielded to meet the EMC requirements.

Encoder interface - drive side

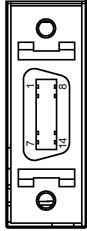
Illustration	Pin No.	Signal name	Description
	1	Biss_DataP	Absolute encoder data signal, positive
	2	Biss_DataN	Absolute encoder data signal, negative
	3	Biss_ClockN	Absolute encoder clock signal, negative
	4	Biss_ClockP	Absolute encoder clock signal, positive
	5	P5V	Encoder power supply, 5 V
	6	P5V	Encoder power supply, 5 V
	7	M	Encoder power supply, grounding
	8	M	Encoder power supply, grounding
	9	Rp	Encoder R phase positive signal
	10	Rn	Encoder R phase negative signal
	11	Bn	Encoder B phase negative signal
	12	Bp	Encoder B phase positive signal
	13	An	Encoder A phase negative signal
	14	Ap	Encoder A phase positive signal
Screw type: UNC 4-40 (plug-in terminal block)			
Tightening torque: 0.4 Nm			

Encoder connector - motor side

Illustration	Pin No.	Incremental encoder TTL 2500 ppr		Illustration	Absolute encoder single-turn 21-bit		
		Signal	Description		Signal	Description	
Low inertia motor, shaft height: 20 mm, 30 mm and 40 mm							
	1	P_Supply	Power supply 5 V		P_Supply	Power supply 5 V	
	2	M	Power supply 0 V		M	Power supply 0 V	
	3	A+	Phase A+		Clock_P	Clock	
	4	B+	Phase B+		Data_P	Data	
	5	R+	Phase R+		n. c.	Not connected	
	6	n. c.	Not connected		P_Supply	Power supply 5 V	
	7	P_Supply	Power supply 5 V		M	Power supply 0 V	
	8	M	Power supply 0 V		Clock_N	Inverted clock	
	9	A-	Phase A-		Data_N	Inverted data	
	10	B-	Phase B-		Shielding	Grounding	
	11	R-	Phase R-		Note		
	12	Shielding	Grounding		The pin11 to pin15 of the absolute encoder connector are not connected.		

Illustration	Pin No.	Incremental encoder TTL 2500 ppr		Absolute encoder single-turn 21-bit Absolute encoder 20-bit + 12-bit multi-turn	
		Signal	Description	Signal	Description
Low inertia motor, shaft height: 50 mm					
High inertia motor, shaft height: 45 mm, 65 mm, and 90 mm					
Straight connectors:  Angular connectors: 	1	P_Supply	Power supply 5 V	P_Supply	Power supply 5 V
	2	M	Power supply 0 V	M	Power supply 0 V
	3	A+	Phase A+	n. c.	Not connected
	4	A-	Phase A-	Clock_N	Inverted clock
	5	B+	Phase B+	Data_P	Data
	6	B-	Phase B-	Clock_P	Clock
	7	R+	Phase R+	n. c.	Not connected
	8	R-	Phase R-	Data_N	Inverted data

Wiring

Low inertia motor, shaft height: 20 mm, 30 mm and 40 mm

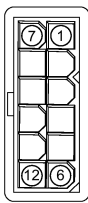
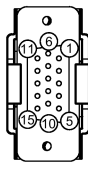
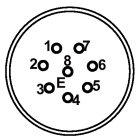
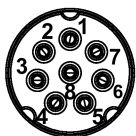
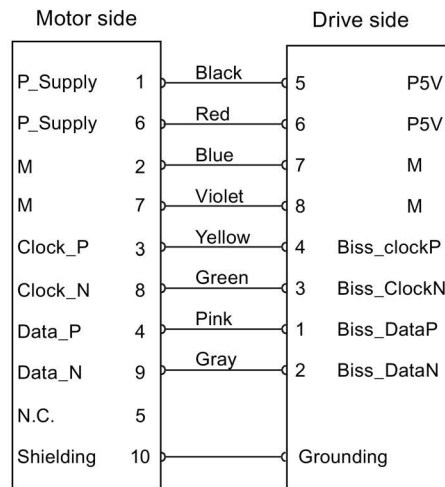
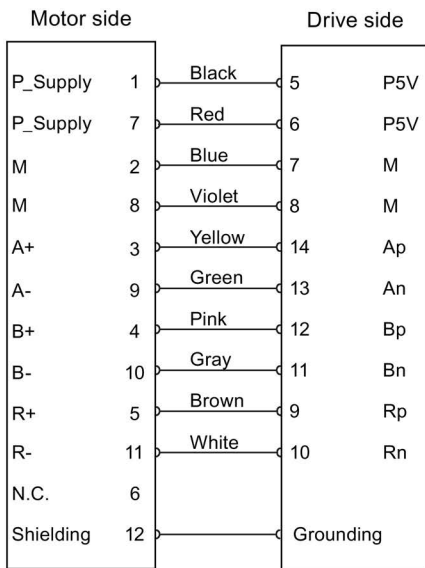

Absolute encoder single-turn 21-bit

Incremental encoder TTL 2500 ppr

Low inertia motor, shaft height: 50 mm

High inertia motor, shaft height: 45 mm, 65 mm, and 90 mm

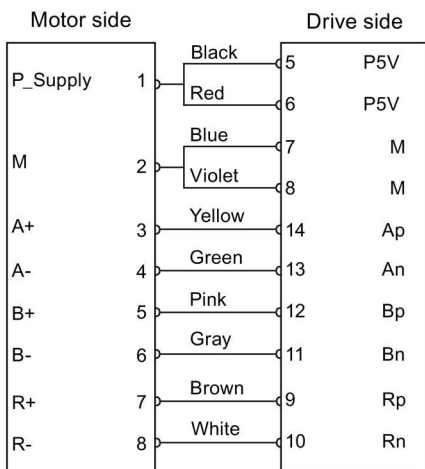

Incremental encoder TTL 2500 ppr

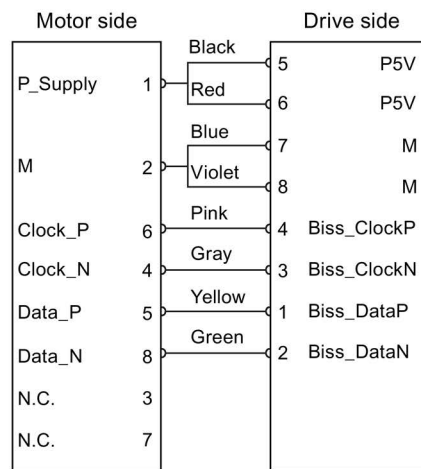

Absolute encoder single-turn 21-bit
Absolute encoder 20-bit + 12-bit multi-turn

Grounding

To ensure better EMC effects, you are recommended to strip the encoder cable and connect the cable shield to earth, as shown in the following figure:

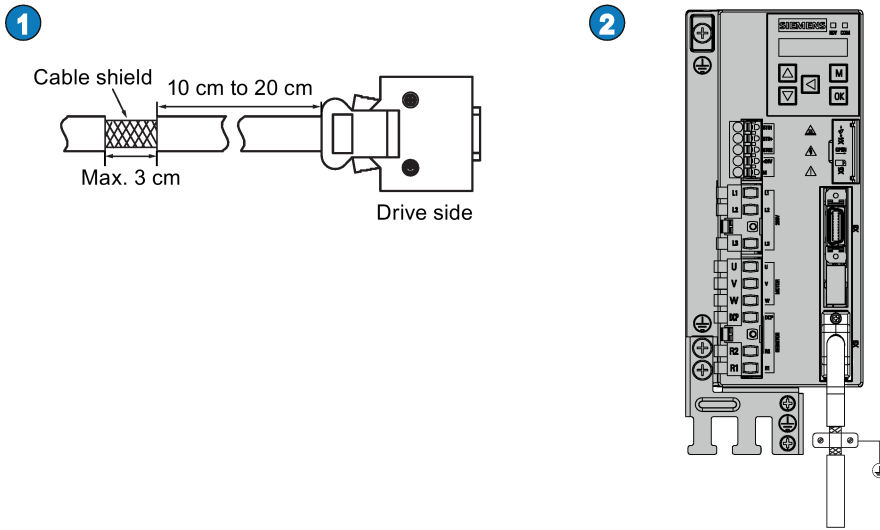

4.6 External braking resistor - DCP, R1

The SINAMICS V90 PN has been designed with an internal braking resistor to absorb regenerative energy from the motor. When the internal braking resistor cannot meet the braking requirements (e.g. the alarm A52901 is generated), you can connect an external braking resistor. For more information about how to select a braking resistor, see Section "Accessories" in the SINAMICS V90, SIMOTICS S-1FL6 Operating Instructions.

Note

The 200 V variant servo drive with rated power of 0.1 kW does not have a built-in resistor.

Connecting an external braking resistor

NOTICE

Damage to the drive due to not moving the short-circuit stick between terminals DCP and R2

There is a damage to the drive if you do not move the short-circuit stick between terminals DCP and R2 when using an external resistor.

- Before connecting an external resistor to DCP and R1, remove the connection between terminals DCP and R2.

For more information about how to connect the external braking resistor, see Section "System connection (Page 41)".

4.7 Motor holding brake

You can connect the SINAMICS V90 PN servo drive to a servo motor with brake to use the function of motor holding brake.

NOTICE

Motor brake service life shortened due to the improper use

The motor brake is used for holding purpose only. Frequent emergency stops with the motor brake will shorten its service life.

- Unless absolutely necessary, do not apply the motor brake as an emergency stop or deceleration mechanism.

4.8 PROFINET interface - X150

PROFINET interface

PROFINET devices from the SINAMICS family have a PROFINET interface (Ethernet-controller/interface) with two ports (physical connection possibilities).

Every PROFINET device on the network is uniquely identified via its PROFINET interface. For this purpose, each PROFINET interface has:

- A MAC address (factory default)
- An IP address
- A device name (name of the station)

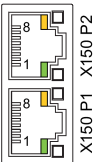
Illustration	Pin	PROFINET communication port 1 - P1		PROFINET communication port 2 - P2	
		Signal	Description	Signal	Description
	1	P1RXP	Port 1 receive data +	P2RXP	Port 2 receive data +
	2	P1RXN	Port 1 receive data -	P2RXN	Port 2 receive data -
	3	P1TXP	Port 1 transmit data +	P2TXP	Port 2 transmit data +
	4	PE terminal	Protective earthing	PE terminal	Protective earthing
	5	PE terminal	Protective earthing	PE terminal	Protective earthing
	6	P1TXN	Port 1 transmit data -	P2TXN	Port 2 transmit data -
	7	PE terminal	Protective earthing	PE terminal	Protective earthing
	8	PE terminal	Protective earthing	PE terminal	Protective earthing

LED displays

For diagnostic purposes, the RJ45 sockets are each equipped with a green and an orange LED. This allows the following status information about the respective PROFINET port to be displayed:

Name	Color	Status	Meaning
Link	Green	lit	Transfer rate 100 Mbit/s
		off	No or faulty connection
Activity	Orange	lit	Data exchange
		off	No data exchange

Wiring

The maximum length of cables between stations (L1 to Ln) is 100 m. For a long cable, you are recommended to fix it on the cabinet to prevent the connector damage caused by dragging.

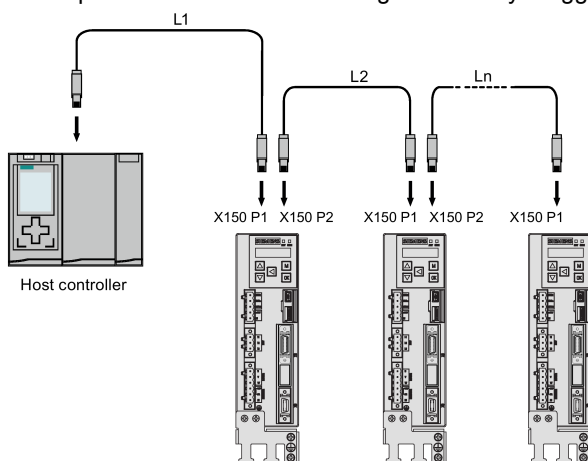

Note

When connecting the ports P1 and P2, you need to make sure that the physical input and output connections are the same with the connections in the topology.

5 Commissioning

Prior to commissioning, read "Introduction to the BOP (Page 59)" for more information about the BOP operations. In case of any faults or alarms during commissioning, refer to Chapter "Diagnostics (Page 117)" for detailed description.

CAUTION

Danger to injury resulting from failure to observe the safety instructions

Failure to observe the instructions can result in serious injuries.

- Before your commissioning or operation, read the safety instructions in Chapter "Fundamental safety instructions (Page 3)" carefully.

WARNING

Material damages and personal injuries by the drop of a hanging axis

When the servo system is used as a hanging axis, the axis will drop if the positive and negative poles of the 24 V power supply are connected inversely. Unexpected drop of the hanging axis may cause material damages and personal injuries.

- Before commissioning, you need to make sure that a crosstie is used to hold the hanging axis in prevention of an unexpected drop. In addition, make sure that the 24 V power supply is correctly connected.

NOTICE

Firmware damage due to drive power-off during data transfer

Switching off the 24 V power supply for the drive during data transfer from the micro SD card/SD card to the drive can cause damage to the drive firmware.

- Do not switch off the drive power supply when the data transfer from the micro SD card/SD card to the drive is in process.

NOTICE

Existing setting data is overwritten by the setting data on the micro SD card/SD card during the drive startup

Existing setting data is overwritten by the setting data on the micro SD card/SD card during the drive startup. This situation occurs when a drive is switched on with a micro SD card/SD card containing user setting data, the existing setting data on the drive will be overwritten, or when a drive is switched on with a micro SD card/SD card containing no user setting data, the drive will automatically save the existing user setting data onto the micro SD card/SD card.

- Before starting up the drive with a micro SD card/SD card, check whether the micro SD card/SD card contains user setting data. Otherwise, the existing data on the drive may be overwritten.

Note

Plugging or unplugging the micro SD card/SD card will cause startup failure.

Do not plug or unplug the micro SD card/SD card during startup; otherwise, the drive will fail to start up.

Note

In S control mode, if the motor shaft is blocked, the blocked torque is the current effective torque. Long time shaft blocking can cause damage to the motor.

Engineering tool - SINAMICS V-ASSISTANT

You can use the engineering tool SINAMICS V-ASSISTANT to perform the trial operation.

SINAMICS V-ASSISTANT is a software tool that can be installed on a PC and runs on the Windows operating system. It communicates with the SINAMICS V90 PN servo drive with a USB cable (To ensure the stability of online commissioning, Siemens recommends you to use a shielded USB cable of no longer than 3 m with ferrite cores on both ends.). With SINAMICS V-ASSISTANT, you can change drive parameters and monitor drive working states in online mode.

For more information, refer to SINAMICS V-ASSISTANT Online Help. You can search and download SINAMICS V-ASSISTANT from Technical support website (<https://support.industry.siemens.com/cs/ww/en/>).

5.1 Introduction to the BOP

Overview

The SINAMICS V90 PN servo drive is designed with a Basic Operator Panel (BOP) on the front panel of the servo drive:

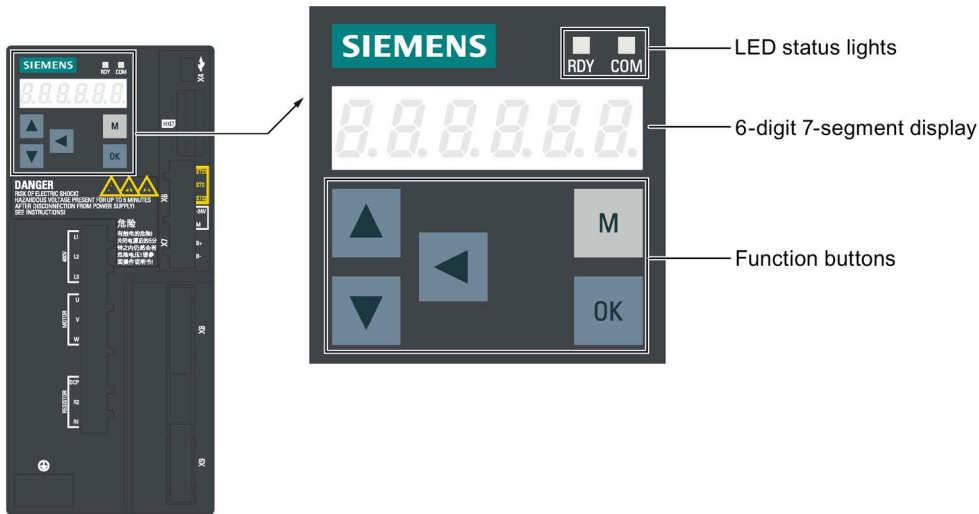

You can use the BOP for the following operations:

- Standalone commissioning
- Diagnosis
- Parameter access
- Parameter settings
- Micro SD card/SD card operations
- Drive restart

LED status indicators



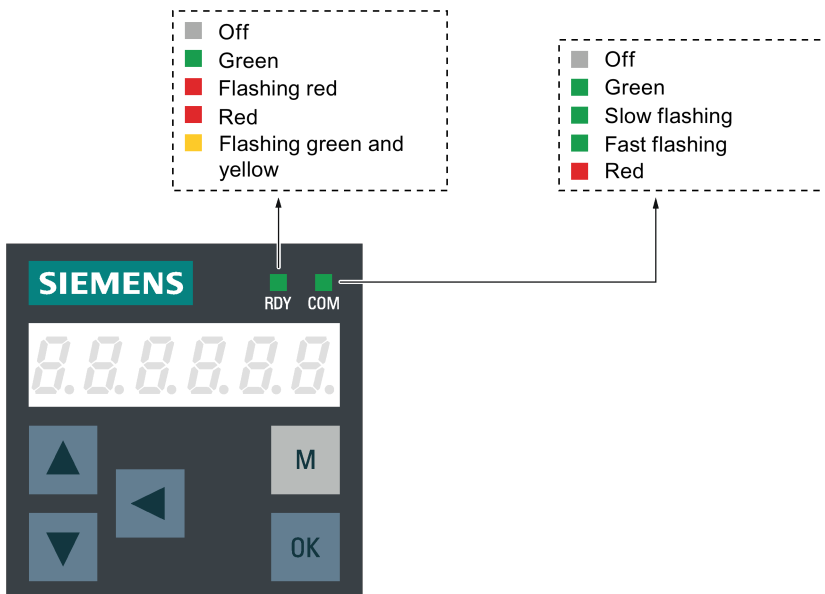







Two LED status indicators (RDY and COM) are available to indicate drive status. Both LEDs are tricolor (green/red/yellow).



You can find detailed information about the status indications in the table below:

Status indicator	Color	Status	Description
RDY	-	Off	24 V control board power supply is missing
	Green	Continuously lit	The drive is in "servo on" state
	Red	Continuously lit	The drive is in "servo off" state or in the startup state
		Flash at 1 Hz	Alarms or faults occurs
	Green and yellow	Flash alternatively at 2 Hz	Drive identification
COM	Green	Continuously lit	PROFINET communication is working with IRT
		Flash at 0.5 Hz	PROFINET communication is working with RT
		Flash at 2 Hz	Micro SD card/SD card operating (read or write)
	Red	Continuously lit	Communication error (always put the PROFINET communication error as the first consideration)

Control buttons







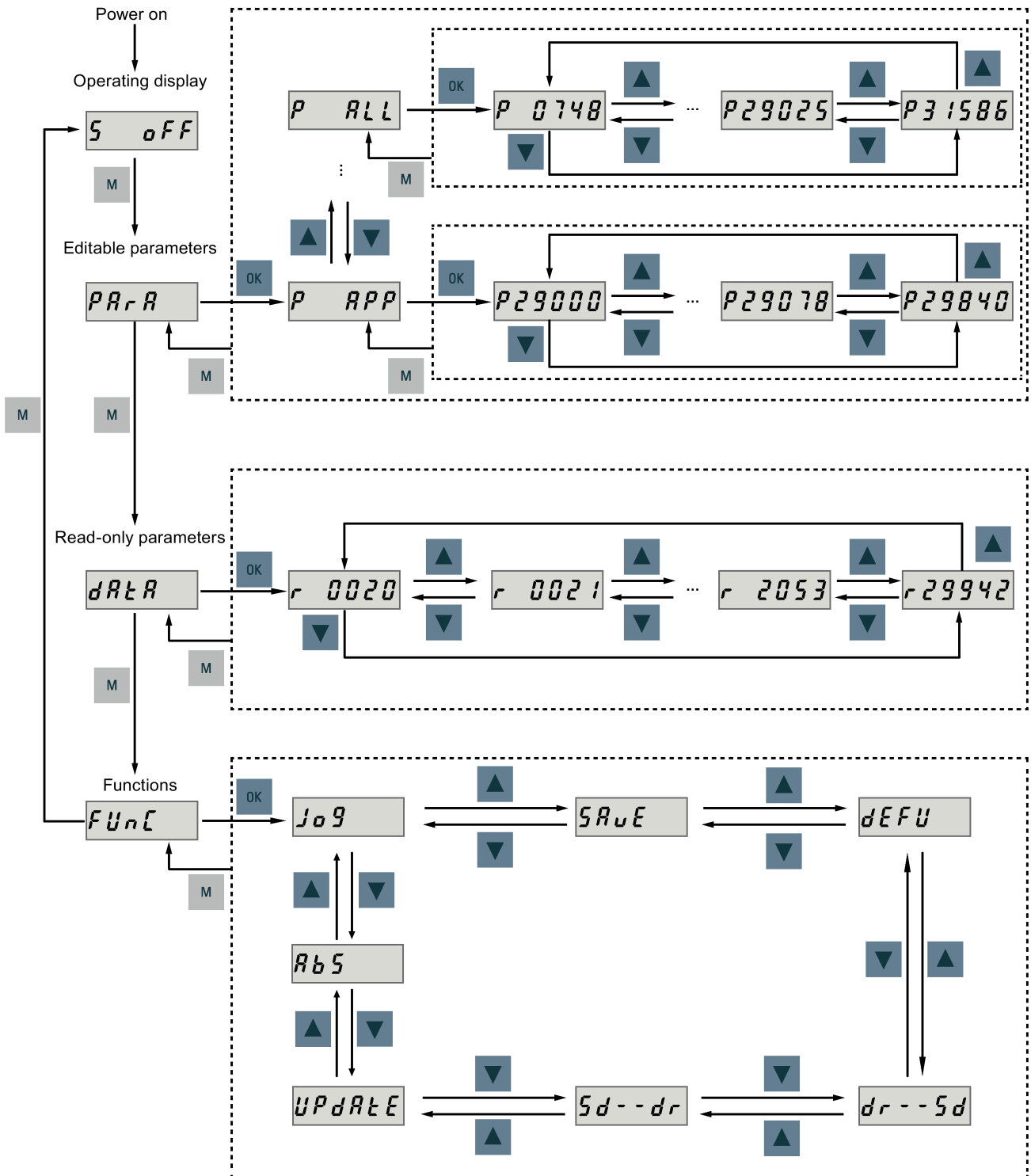

Button	Description	Functions
	M button	<ul style="list-style-type: none"> Exits from the current menu Switches between operating modes in the top level menu
	OK button	<p>Short-pressing:</p> <ul style="list-style-type: none"> Confirms selection or input Enters sub menu Acknowledges faults <p>Long-pressing:</p> <p>Activates auxiliary functions</p> <ul style="list-style-type: none"> JOG Saves parameter set in drive (RAM to ROM) Sets parameter set to default Transfers data (drive to micro SD card/SD card) Transfers data (micro SD card/SD card to drive) Updates firmware
	UP button	<ul style="list-style-type: none"> Navigates to the next item Increases a value JOG in CW (clockwise)
	DOWN button	<ul style="list-style-type: none"> Navigates to the previous item Decreases a value JOG in CCW (counter-clockwise)
	SHIFT button	<p>Moves the cursor from digit to digit for single digit editing, including the digit of positive/negative sign</p> <p>Note: When the sign is edited, "_" indicates positive and "-" indicates negative.</p>
	Press the key combination for four seconds to restart the drive	
	Moves current display to the left page when  is displayed at the upper right corner, for example <i>00.000r</i> .	
	Moves current display to the right page when  is displayed at the lower right corner, for example <i>00 10l</i> .	

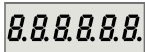

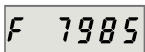
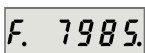
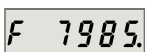
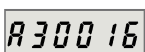

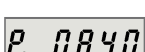
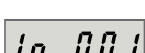

Menu structure

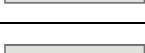
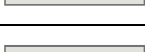
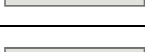
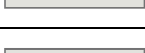
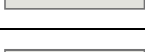

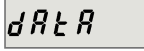

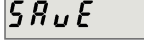
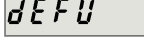
The overall parameter structure of SINAMICS V90 PN BOP is designed as follows:

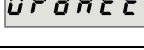
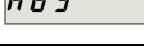
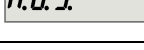
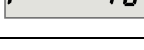

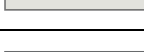
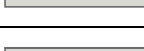
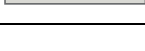
BOP displays

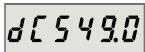
Display	Example	Description
8.8.8.8.8.8.		Drive is in startup state
-----		Drive is busy
Fxxxxx		Fault code, in the case of a single fault
F.xxxxx.		Fault code of the first fault, in the case of multiple faults
Fxxxxx.		Fault code, in the case of multiple faults
Axxxxx		Alarm code, in the case of a single alarm
A.xxxxx.		Alarm code of the first alarm, in the case of multiple alarms
Axxxxx.		Alarm code, in the case of multiple alarms
Rxxxxx		Parameter number, read-only parameter
Pxxxxx		Parameter number, editable parameter
P.xxxxx		Parameter number, editable parameter; the dot means that at least one parameter has been changed
In xxx		Indexed parameter Figure after "In" indicates the number of indices. For example, "In 001" means that this indexed parameter is 1.
xxx.xxx		Negative parameter value
xxx.xx<>		Current display can be moved to left or right
xxxx.xx>		Current display can be moved to right
xxxx.xx<		Current display can be moved to left
S Off		Operating display: servo off
Para		Editable parameter group

Display	Example	Description
P xxxx		Parameter group Five groups are available: 1. P APP : application 2. P BASE : basic 3. P CON : communication 4. P EPOS : basic positioner 5. P ALL : all parameters
Data		Read-only parameter group
Func		Function group
JOG		JOG function
Save		Save data in drive
defu		Restore drive to default settings
dr--sd		Save data from drive to micro SD card/SD card
sd--dr		Upload data from micro SD card/SD card to drive
Update		Update firmware
ABS		The zero position has not been set
A.B.S.		The zero position has been set
r xxx		Actual speed (positive direction)
r -xxx		Actual speed (negative direction)
T x.x		Actual torque (positive direction)
T -x.x		Actual torque (negative direction)
xxxxxx		Actual position (positive direction)
xxxxxx.		Actual position (negative direction)

Display	Example	Description
DCxxx.x		Actual DC link voltage
Exxxxx		Position following error
run		The motor is running
Con		The communication between the commissioning tool SINAMICS V-ASSISTANT and the servo drive is established. In this case, the BOP is protected from any operations except clearing alarms and acknowledging faults.

5.2 Initial commissioning in JOG mode

Prerequisites

- The servo drive is connected to the servo motor without load
- The servo drive is not in servo on status

Operating sequence

Note

Set bit 0 of parameter p29108 to 1, and then save the parameter setting and restart the drive, to enable the JOG function; otherwise, you cannot access the function related parameter p1058.

If you have assigned digital signal EMGS, keep it at a high level (1) to ensure normal operation.

Step	Description	Remarks
1	Connect necessary units and check wiring.	It is necessary to connect the following cables: <ul style="list-style-type: none"> • Power cable • Encoder cable • Brake cable • Line supply cable • 24 VDC cable
2	Switch on the 24 VDC power supply.	
3	Check the servo motor type. <ul style="list-style-type: none"> • If the servo motor has an incremental encoder, input motor ID (p29000). • If the servo motor has an absolute encoder, the servo drive can identify the servo motor automatically. 	Fault F52984 occurs when the servo motor is not identified. You can find the motor ID from the motor rating plate. Go to "Motor components (Page 14)" for detailed descriptions about motor rating plate.
4	Check the direction of motor rotation. The default direction of rotation is CW (clockwise). You can change it by setting the parameter p29001 if necessary.	p29001=0: CW p29001=1: CCW

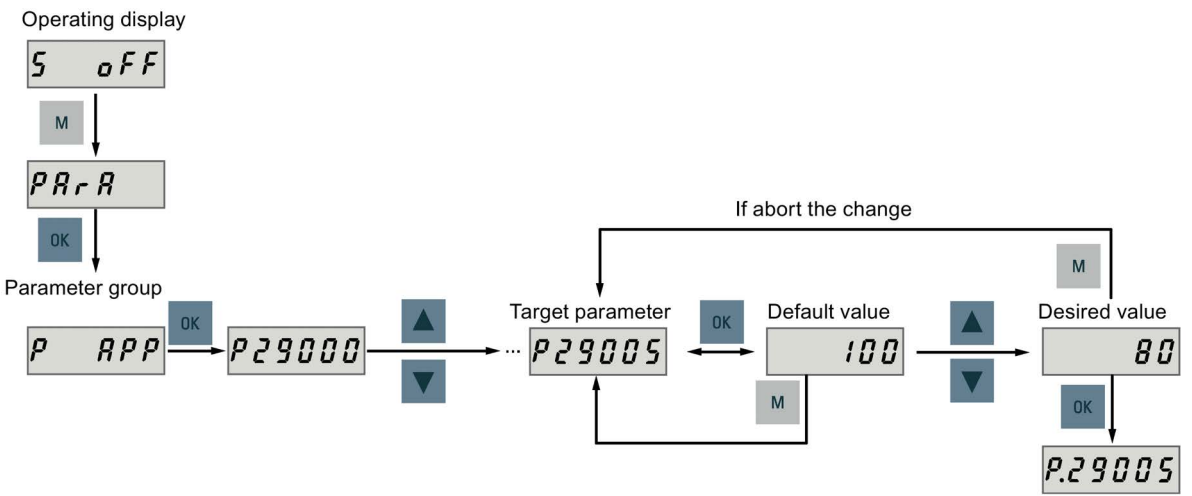
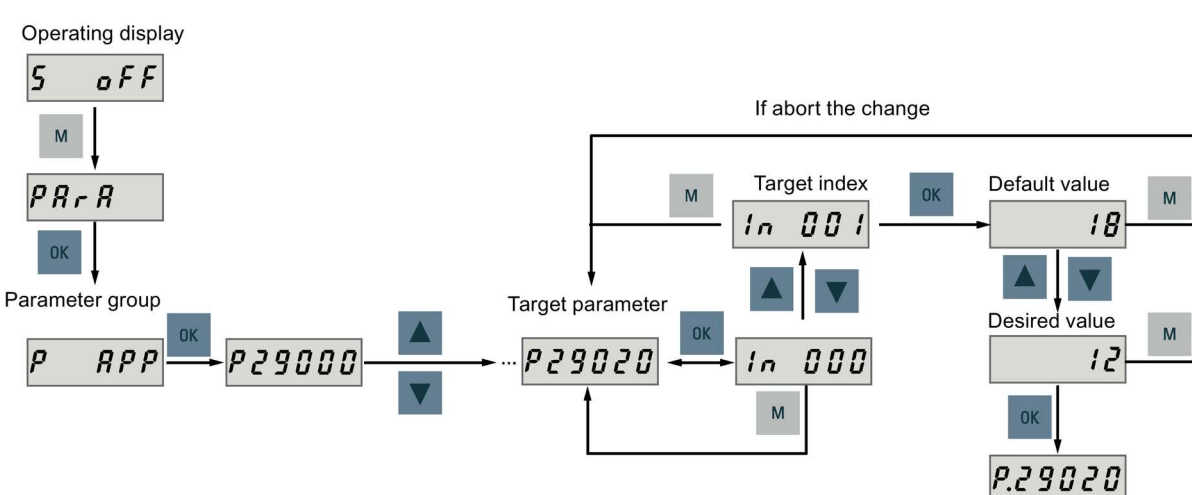
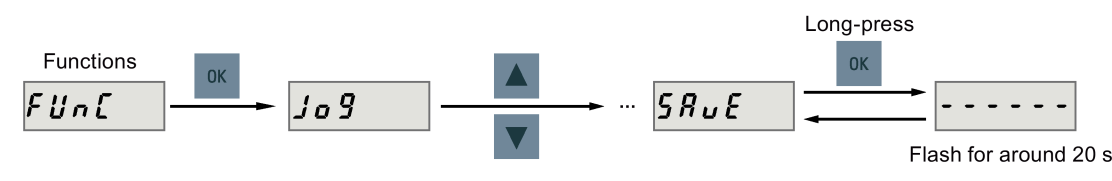
Step	Description	Remarks
	<p>Setting a parameter without index (example)</p> <p>Operating display </p> <p>Setting a parameter with index (example)</p> <p>Operating display </p>	
5	<p>Check the JOG speed. The default JOG speed is 100 rpm. You can change it by setting the parameter p1058.</p>	<p>Set bit 0 of parameter p29108 to 1, and then save the parameter setting and restart the drive, to enable the JOG function; otherwise, you cannot access p1058.</p>
6	<p>Save parameters with the BOP.</p> 	
7	<p>Switch on the main line supply.</p>	
8	<p>Clear faults and alarms.</p>	<p>Refer to "Diagnostics (Page 117)".</p>
9	<p>For the BOP, enter the JOG menu function and press the UP or DOWN button to run the servo motor. For the engineering tool, use the JOG function to run the servo motor.</p>	<p>For more information about JOG with SINAMICS V-ASSISTANT, see SINAMICS V-ASSISTANT Online Help.</p>

Step	Description	Remarks
	<p>JOG in speed (example)</p> <p>JOG in torque (example)</p>	

5.3 Commissioning in basic positioner control mode (EPOS)

The following takes the EJOG function for example to describe the commissioning in EPOS mode.

Step	Description	Remarks
1	Switch off the main line supply.	
2	Power off the servo drive and connect it to the controller (for example, SIMATIC S7-1500) with the PROFINET cable and signal cable.	If any one of digital signals EMGS, CWL, and CCWL is not assigned to a DI, it will be set to a high level (1) automatically. If you have assigned any one of digital signals EMGS, CWL, and CCWL to a DI, keep it at a high level (1).
3	Switch on the 24 VDC power supply.	
4	Check the servo motor type. <ul style="list-style-type: none"> If the servo motor has an incremental encoder, input the motor ID (p29000). If the servo motor has an absolute encoder, the servo drive can identify the servo motor automatically. 	Fault F52984 occurs when the servo motor is not identified. You can find the motor ID from the motor rating plate. For the detailed information of the motor rating plate, see Section "Motor components (Page 14)".
5	Switch to the basic positioner control mode by setting parameter p29003 = 1.	<ul style="list-style-type: none"> p29003 = 1: basic positioner control (EPOS) p29003 = 2: speed control (S)
6	Save the parameter and restart the servo drive to apply the setting of the basic positioner control mode.	
7	Set the mechanical gear ratio with parameters p29247, p29248 and p29249.	<ul style="list-style-type: none"> p29247: LU per load revolution p29248: load revolutions p29249: motor revolutions

Step	Description	Remarks
8	Select the axis type by setting parameter p29245. If you use the modular axis, you need to define the modular range by setting parameter p29246.	<ul style="list-style-type: none"> p29245 = 0: linear axis p29245 = 1: modular axis
9	Setting jogging setpoints with the appropriate parameters. <ul style="list-style-type: none"> Velocity (p2585, p2586) Incremental (p2587, p2588) 	Refer to "EJOG (Page 70)".
10	Switch on the main line supply.	
11	Set up the PROFINET configuration with TIA Portal.	
12	Select the telegram for PROFINET communication with parameter p0922.	

5.4 Commissioning in speed control mode (S)

Step	Description	Remarks
1	Switch off the main line supply.	
2	Power off the servo drive and connect it to the controller (for example, SIMATIC S7-1500) with the PROFINET cable and signal cable.	<p>If any one of digital signals EMGS, CWL, and CCWL is not assigned to a DI, it will be set to a high level (1) automatically.</p> <p>If you have assigned any one of digital signals EMGS, CWL, and CCWL to a DI, keep it at a high level (1).</p>
3	Switch on the 24 VDC power supply.	
4	Check the servo motor type. <ul style="list-style-type: none"> If the servo motor has an incremental encoder, input motor ID (p29000). If the servo motor has an absolute encoder, the servo drive can identify the servo motor automatically. 	<p>Fault F52984 occurs when the servo motor is not identified.</p> <p>You can find the motor ID from the motor rating plate. Go to "Motor components (Page 14)" for detailed descriptions about motor rating plate.</p>
5	Set up the PROFINET configuration with TIA Portal.	
6	Select the telegram for PROFINET communication with parameter p0922.	
7	Set the IP address for the station with parameters p8921, p8923.	
8	Set the device name for the station with parameter p8920.	The device name must be unique within the PROFINET network.
9	Active the IP configuration and device name with parameter p8925.	
10	Set the torque limitation and speed limitation.	Refer to "Torque limit (Page 69)" and "Speed limit (Page 68)".
11	Configure necessary digital input signals by setting the following parameters: <ul style="list-style-type: none"> p29301: DI1 p29302: DI2 p29303: DI3 p29304: DI4 	<p>The factory settings are:</p> <ul style="list-style-type: none"> p29301: 2 (RESET) p29302: 11 (TLIM) p29303: 0 p29304: 0
12	Save parameters with the BOP and restart the drive.	
13	Switch on the main line supply.	
14	Clear faults and alarms.	Refer to "Diagnostics (Page 117)".
15	Send and receive the process data (PZD) with TIA Portal.	<p>The actual speed of the servo motor can be viewed from the BOP operating display.</p> <p>The default display is the actual speed.</p>

5.5 Commissioning control functions

5.5.1 Speed limit

Two sources in total are available for the speed limit. You can select one of them via the digital input signal SLIM:

Digital signal (SLIM)	Speed limit
0	Internal speed limit 1
1	Internal speed limit 2

Note

The bit 0 of parameter p29108 **must** be set to 1 to enable the speed limit function.

Note

You can switch between the two sources and modify their values when the servo drive is running.

Note

Fault F7901 occurs when the actual speed exceeds the positive speed limit + hysteresis speed (p2162) or the negative speed limit - hysteresis speed (p2162).

Overall speed limit

Besides the above two channels, an overall speed limit is also available.

You can configure the overall speed limit by setting the following parameters:

Parameter	Value range	Default	Unit	Description
p1083	0 to 210000	210000	rpm	Overall speed limit (positive)
p1086	-210000 to 0	-210000	rpm	Overall speed limit (negative)

Internal speed limit

Select an internal speed limit by setting the following parameters:

Parameter	Value range	Default	Unit	Description	Digital input (SLIM)
p29070[0]	0 to 210000	210000	rpm	Internal speed limit 1 (positive)	0
p29070[1]	0 to 210000	210000	rpm	Internal speed limit 2 (positive)	1
p29071[0]	-210000 to 0	-210000	rpm	Internal speed limit 1 (negative)	0
p29071[1]	-210000 to 0	-210000	rpm	Internal speed limit 2 (negative)	1

Note

After the motor is commissioned, p1082, p1083, p1086, p29070 and p29071 are set to the maximum speed of the motor automatically.

5.5.2 Torque limit

Two sources in total are available for the torque limit. You can select one of them via the digital input signal TLIM:

Digital input (TLIM)	Torque limit
0	Internal torque limit 1
1	Internal torque limit 2

When the torque setpoint reaches torque limit, the torque is limited to the value selected by TLIM.

Note

You can switch between the two sources and modify their values when the servo drive is running.

Overall torque limit

Besides the above two sources, an overall torque limit is also available. The overall torque limit takes effect when an emergency stop (OFF3) happens. In this case, the servo drive brakes with a maximum torque.

You can configure the overall torque limit by setting the following parameters:

Parameter	Value range	Default	Unit	Description
p1520	-1000000.00 to 2000000.00	0	Nm	Overall torque limit (positive)
p1521	-2000000.00 to 1000000.00	0	Nm	Overall torque limit (negative)

Internal torque limit

Select an internal torque limit by setting the following parameters:

Parameter	Value range	Default	Unit	Description	Digital input (TLIM)
p29050[0]	-150 to 300	300	%	Internal torque limit 1 (positive)	0
p29050[1]	-150 to 300	300	%	Internal torque limit 2 (positive)	1
p29051[0]	-300 to 150	-300	%	Internal torque limit 1 (negative)	0
p29051[1]	-300 to 150	-300	%	Internal torque limit 2 (negative)	1

The following diagram shows how the internal torque limit functions:

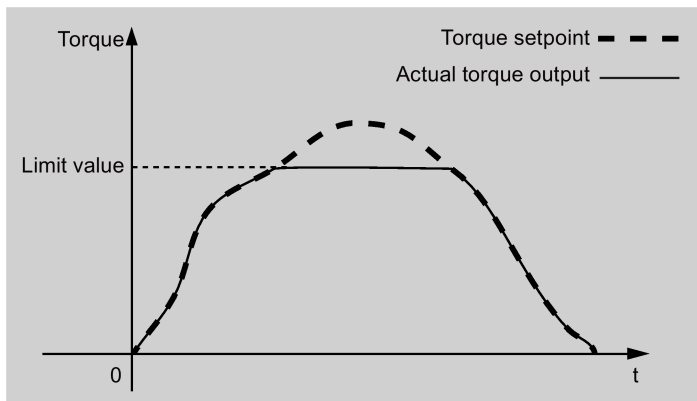

Torque limit reached (TLR)

When the generated torque has nearly (internal hysteresis) reached the value of the positive torque limit or negative torque limit, the signal TLR is output.

5.5.3 EJOG

When telegrams 7, 9, 110, and 111 are used, select a jogging channel with the PROFINET control words STW1.8 and STW1.9:

Control word	Setting	Description
STW1.8	0	No jogging channel activated.
STW1.9	1	Jog 1 signal source rising edge activated.
	2	Jog 2 signal source rising edge activated.
	3	Reserved.

Features

Selecting a jogging mode

When telegram 110 is used, select a jogging mode with the PROFINET control word POS_STW.5:

Control word	Setting	Description
POS_STW.5	1	Jogging, incremental active.
	0	Jogging, velocity active.

When telegram 111 is used, select a jogging mode with the PROFINET control word POS_STW2.5:

Control word	Setting	Description
POS_STW2.5	1	Jogging, incremental active.
	0	Jogging, velocity active.

Note

When telegrams 7 and 9 are used, endless jogging is fixed.

Setting jogging setpoints

When telegrams 7 and 9 are used, set the following jogging setpoint with the appropriate parameters:

- Velocity (p2585, p2586)

When telegrams 110, and 111 are used, set the following jogging setpoints with the appropriate parameters:

- Velocity (p2585, p2586)
- Incremental (p2587, p2588)

Overview of important parameters

- p2585 EPOS jog 1 setpoint velocity
- p2586 EPOS jog 2 setpoint velocity
- p2587 EPOS jog 1 travel distance
- p2588 EPOS jog 2 travel distance

For more information about the parameters above, see Section "Parameter list (Page 86)".

6 PROFINET communication

PROFINET IO is a real time protocol based on Ethernet. It is used as high level network for industrial automation applications. PROFINET IO focuses on the data exchange for a programmable controller. A PROFINET IO network consists of the following devices:

- IO controller: typically, it is the PLC, which controls the whole application
- IO device: a decentralized IO device (for example, encoder, sensor), which is controlled by the IO controller
- IO supervisor: HMI (human machine interface) or PC for diagnostic purposes or commissioning

PROFINET supplies two kinds of real time communication, that is, PROFINET IO RT (Real Time) and PROFINET IO IRT (Isochronous Real Time). The real time channel is used for IO data and alarm mechanism.

In PROFINET IO RT, the RT data is transferred via a prioritized Ethernet frame. No special hardware is required. Due to this prioritization a cycle time of 4 ms can be achieved. PROFINET IO IRT is used for more precise timing requirements. Cycle time of 2 ms is possible, but also special hardware for IO devices and switches are required.

All diagnostic and configuration data is transferred via the non-real time channel (NRT). For this purpose the common TCP/IP protocol is used. Anyhow, no timing can be guaranteed and typically the cycle times can be more than 100 ms.

6.1 Supported telegrams

SINAMICS V90 PN supports standard telegrams and Siemens telegrams for speed control mode and basic positioner control mode. You can select the desired telegram with parameter p0922. See the following table for details.

From the perspective of the drive unit, the received process data represents the receive words and the process data to be sent represents the send words.

Telegram	Maximum number of PZD		Description
	Receive word	Send word	
Standard telegram 1	2	2	p0922 = 1
Standard telegram 2	4	4	p0922 = 2
Standard telegram 3	5	9	p0922 = 3
Standard telegram 5	9	9	p0922 = 5
Standard telegram 7	2	2	p0922 = 7
Standard telegram 9	10	5	p0922 = 9
Siemens telegram 102	6	10	p0922 = 102
Siemens telegram 105	10	10	p0922 = 105
Siemens telegram 110	12	7	p0922 = 110
Siemens telegram 111	12	12	p0922 = 111

One PZD = one word

Standard telegram 5 and Siemens telegram 105 can only be used when the V90 PN connects to the SIMATIC S7-1500 and the TIA Portal version is V14 or higher.

Telegrams used for speed control mode

Telegram	1		2		3		5		102		105			
Appl. class	1		1		1, 4		4		1, 4		4			
PZD1	STW1	ZSW1	STW1	ZSW1	STW1	ZSW1	STW1	ZSW1	STW1	ZSW1	STW1	ZSW1		
PZD2	NSOLL_A	NIST_A	NSOLL_B	NIST_B	NSOLL_B	NIST_B	NSOLL_B	NIST_B	NSOLL_B	NIST_B	NSOLL_B	NIST_B		
PZD3	↑ Receive telegram from PROFINET	↓ Send telegram to PROFINET												
PZD4			STW2	ZSW2	STW2	ZSW2	STW2	ZSW2	STW2	ZSW2	STW2	ZSW2	ZSW2	
PZD5							G1_STW	G1_ZSW	G1_STW	G1_ZSW	MOMRED	MELDW	MOMRED	MELDW
PZD6							G1_XIS T1	XERR	G1_XIS T1		G1_STW	G1_ZSW	G1_STW	G1_ZSW
PZD7												G1_XIS T1	XERR	G1_XIS T1
PZD8							G1_XIS T2	KPC	G1_XIS T2					G1_XIS T2
PZD9												G1_XIS T2	KPC	G1_XIS T2
PZD10														

Telegrams used for basic positioner control mode

Telegram	7		9		110		111	
Appl. class	3		3		3		3	
PZD1	STW1	ZSW1	STW1	ZSW1	STW1	ZSW1	STW1	ZSW1
PZD2	SATZANW	AKTSATZ	SATZANW	AKTSATZ	SATZANW	AKTSATZ	POS_STW 1	POS_ZSW 1
PZD3	↑ Receive telegram from PROFINET	↓ Send telegram to PROFINET	STW2	ZSW2	POS_STW	POS_ZSW	POS_STW 2	POS_ZSW 2
PZD4			MDI_TARPOS	XIST_A	STW2	ZSW2	STW2	ZSW2
PZD5					OVERVERRIDE	MELDW	OVERVERRIDE	MELDW
PZD6			MDI_VELOCITY		MDI_TAR POS	XIST_A	MDI_TAR POS	XIST_A
PZD7								
PZD8			MDI_ACC		MDI_VELO CITY		MDI_VELO CITY	NIST_B
PZD9			MDI_DEC					
PZD10			MDI_MOD		MDI_ACC		MDI_ACC	FAULT_CO DE
PZD11					MDI_DEC		MDI_DEC	WARN_CO DE
PZD12					MDI_MODE		user ¹⁾	user ²⁾

1) User-defined receive word

2) User-defined send word

Note

When you use the telegram 110 and 111 in EPOS functions JOG, MDI, traversing block, and referencing, the value of the PZD5 OVERRIDE affects the speed.

6.2 I/O data signals

Parameters p200x apply as reference variables (telegram contents = 4000 hex or 40000000 hex in the case of double words if the input variable has the value p200x).

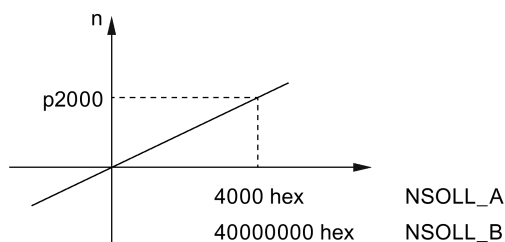

The following table provides an overview of the I/O data used in the telegram.

Signal	Description	Receive word/send word	Data type	Scaling
STW1	Control word 1	Receive word	U16	-
STW2	Control word 2	Receive word	U16	-
ZSW1	Status word 1	Send word	U16	-
ZSW2	Status word 2	Send word	U16	-
NSOLL_A	Speed setpoint A (16 bit)	Receive word	I16	4000 hex \triangleq p2000
NSOLL_B	Speed setpoint B (32 bit)	Receive word	I32	40000000 hex \triangleq p2000
NIST_A	Speed actual value A (16 bit)	Send word	I16	4000 hex \triangleq p2000
NIST_B	Speed actual value B (32 bit)	Send word	I32	40000000 hex \triangleq p2000
G1_STW	Encoder 1 control word	Receive word	U16	-

Signal	Description	Receive word/send word	Data type	Scaling
G1_ZSW	Encoder 1 status word	Send word	U16	-
G1_XIST1	Encoder 1 actual position 1	Send word	U32	-
G1_XIST2	Encoder 1 actual position 2	Send word	U32	-
MOMRED	Torque reduction	Receive word	I16	4000 hex \triangleq p2003
MELDW	Message word	Send word	U16	-
KPC	Position controller gain factor	Receive word	I32	-
XERR	Position deviation	Receive word	I32	-
SATZANW	Position block selection	Receive word	U16	-
AKTSATZ	Selected position block	Send word	U16	-
MDI_TAR POS	MDI position	Receive word	I32	1 hex \triangleq 1 LU
MDI_VELO CITY	MDI velocity	Receive word	I32	1 hex \triangleq 1000 LU/min
MDI_ACC	MDI acceleration override	Receive word	I16	4000 hex \triangleq 100%
MDI_DEC	MDI deceleration override	Receive word	I16	4000 hex \triangleq 100%
XIST_A	Position actual value A	Send word	I32	1 hex \triangleq 1 LU
OVERRIDE 1)	Position velocity override	Receive word	I16	4000 hex \triangleq 100%
MDI_MODE	Position MDI mode	Receive word	U16	-
FAULT_CO DE	Fault code	Send word	U16	-
WARN_CO DE	Alarm code	Send word	U16	-
POS_ZSW	Position status word	Send word	U16	-
user 2)	User-defined receive word (depends on the value of p29150): <ul style="list-style-type: none"> p29150 = 0: No function p29150 = 1: Torque feed-forward p29150 = 2: Speed feed-forward 	Receive word	I16	<ul style="list-style-type: none"> Torque feedforward (4000 hex \triangleq p2003) Speed feedforward (4000 hex \triangleq p2003)
user	User-defined send word (depends on the value of p29151): <ul style="list-style-type: none"> p29151 = 0: No function p29151 = 1: Actual torque p29151 = 2: Actual absolute current p29151 = 3: DI status 	Send word	I16	<ul style="list-style-type: none"> Actual torque (4000 hex \triangleq p2003) Actual absolute current (4000 hex \triangleq p2003)

1) Make sure that signal OVERRIDE is set to a value from 0 to 32767.

2) When you use the auto-tuning function, values of the torque feedforward and speed feedforward can be overwritten after the tuning function is enabled. If you want to use functions of the torque feedforward and speed feedforward, you need to set their values to the required values again.

6.3 Control word definition

6.3.1 STW1 control word (for telegrams 1, 2, 3, 5)

Note



When p29108.0 = 0, STW1.11 is disabled.

Note

When telegram 5 is used, STW1.4, STW1.5, and STW1.6 are disabled.

Note

STW1.10 must be set to 1 to allow the PLC to control the drive.

Signal	Description
STW1.0	 = ON (pulses can be enabled) 0 = OFF1 (braking with ramp-function generator, then pulse suppression and ready for switching on)
STW1.1	1 = No OFF2 (enable is possible) 0 = OFF2 (immediate pulse suppression and switching on inhibited)
STW1.2	1 = No OFF3 (enable is possible) 0 = OFF3 (braking with the OFF3 ramp p1135, then pulse suppression and switching on inhibited)
STW1.3	1 = Enable operation (pulses can be enabled) 0 = Inhibit operation (suppress pulses)
STW1.4	1 = Operating condition (the ramp-function generator can be enabled) 0 = Inhibit ramp-function generator (set the ramp-function generator output to zero)
STW1.5	1 = Continue ramp-function generator 0 = Freeze ramp-function generator (freeze the ramp-function generator output)
STW1.6	1 = Enable setpoint 0 = Inhibit setpoint (set the ramp-function generator input to zero)
STW1.7	 = 1. Acknowledge faults
STW1.8	Reserved
STW1.9	Reserved
STW1.10	1 = Control via PLC
STW1.11	1 = Setpoint inversion
STW1.12	Reserved
STW1.13	Reserved
STW1.14	Reserved
STW1.15	Reserved

6.3.2 STW2 control word (for telegrams 2, 3, 5)

Signal	Description
STW2.0	Reserved
STW2.1	Reserved
STW2.2	Reserved
STW2.3	Reserved
STW2.4	Reserved
STW2.5	Reserved
STW2.6	Reserved
STW2.7	Reserved

Signal	Description
STW2.8	1 = Traverse to fixed endstop
STW2.9	Reserved
STW2.10	Reserved
STW2.11	Reserved
STW2.12	Master sign-of-life, bit 0
STW2.13	Master sign-of-life, bit 1
STW2.14	Master sign-of-life, bit 2
STW2.15	Master sign-of-life, bit 3



6.3.3 STW1 control word (for telegrams 102, 105)

Note

When telegram 105 is used, STW1.4, STW1.5, and STW1.6 are disabled.

Note

STW1.10 must be set to 1 to allow PLC to control the drive.

Signal	Description
STW1.0	 = ON (pulses can be enabled) 0 = OFF1 (braking with ramp-function generator, then pulse suppression and ready for switching on)
STW1.1	1 = No OFF2 (enable is possible) 0 = OFF2 (immediate pulse suppression and switching on inhibited)
STW1.2	1 = No OFF3 (enable is possible) 0 = OFF3 (braking with the OFF3 ramp p1135, then pulse suppression and switching on inhibited)
STW1.3	1 = Enable operation (pulses can be enabled) 0 = Inhibit operation (suppress pulses)
STW1.4	1 = Operating condition (the ramp-function generator can be enabled) 0 = Inhibit ramp-function generator (set the ramp-function generator output to zero)
STW1.5	1 = Continue ramp-function generator 0 = Freeze ramp-function generator (freeze the ramp-function generator output)
STW1.6	1 = Enable setpoint 0 = Inhibit setpoint (set the ramp-function generator input to zero)
STW1.7	 = 1. Acknowledge faults
STW1.8	Reserved
STW1.9	Reserved
STW1.10	1 = Control via PLC
STW1.11	1 = Ramp-function generator active
STW1.12	1 = Unconditionally open the holding brake
STW1.13	Reserved
STW1.14	Reserved
STW1.15	Reserved

6.3.4 STW2 control word (for telegrams 102, 105)

Note



When p29108.0 = 0, STW2.4 is disabled.

Signal	Description
STW2.0	Reserved
STW2.1	Reserved
STW2.2	Reserved
STW2.3	Reserved
STW2.4	1 = Bypass ramp-function generator
STW2.5	Reserved
STW2.6	1 = Integrator inhibit, speed controller
STW2.7	Reserved
STW2.8	1 = Traverse to fixed endstop
STW2.9	Reserved
STW2.10	Reserved
STW2.11	Reserved
STW2.12	Master sign-of-life, bit 0
STW2.13	Master sign-of-life, bit 1
STW2.14	Master sign-of-life, bit 2
STW2.15	Master sign-of-life, bit 3

6.3.5 STW1 control word (for telegrams 7, 9, 110, 111)

Note

STW1.10 must be set to 1 to allow the PLC to control the drive.

Signal	Description
STW1.0	 = ON (pulses can be enabled) 0 = OFF1 (braking with ramp-function generator, then pulse suppression and ready for switching on)
STW1.1	1 = No OFF2 (enable is possible) 0 = OFF2 (immediate pulse suppression and switching on inhibited)
STW1.2	1 = No OFF3 (enable is possible) 0 = OFF3 (braking with the OFF3 ramp p1135, then pulse suppression and switching on inhibited)
STW1.3	1 = Enable operation (pulses can be enabled) 0 = Inhibit operation (suppress pulses)
STW1.4	1 = Do not reject traversing task 0 = Reject traversing task (ramp-down with the maximum deceleration)
STW1.5	1 = No intermediate stop 0 = Intermediate stop
STW1.6	 = Activate traversing task
STW1.7	 = Acknowledge faults
STW1.8	1 = Jog 1 signal source
STW1.9	1 = Jog 2 signal source
STW1.10	1 = Control via PLC

Signal	Description
STW1.11	1 = Start referencing 0 = Stop referencing
STW1.12	Reserved
STW1.13	↗ = External block change
STW1.14	Reserved
STW1.15	Reserved

6.3.6 STW2 control word (for telegrams 9, 110, 111)

Signal	Description
STW2.0	Reserved
STW2.1	Reserved
STW2.2	Reserved
STW2.3	Reserved
STW2.4	Reserved
STW2.5	Reserved
STW2.6	Reserved
STW2.7	Reserved
STW2.8	1 = Traverse to fixed endstop
STW2.9	Reserved
STW2.10	Reserved
STW2.11	Reserved
STW2.12	Master sign-of-life, bit 0
STW2.13	Master sign-of-life, bit 1
STW2.14	Master sign-of-life, bit 2
STW2.15	Master sign-of-life, bit 3

6.3.7 G1_STW encoder 1 control word

Signal	Description															
G1_STW.0	<table border="1"> <thead> <tr> <th>Function No.</th> <th>Function for bit 7 = 0 (search for reference mark)</th> <th>Function for bit 7 = 1 (flying measurement)</th> </tr> </thead> <tbody> <tr> <td>1</td> <td>Reference mark 1</td> <td>↗ Measuring probe 1</td> </tr> <tr> <td>2</td> <td>Reference mark 2</td> <td>↘ Measuring probe 1</td> </tr> <tr> <td>3</td> <td>Reference mark 3</td> <td>↗ Measuring probe 2</td> </tr> <tr> <td>4</td> <td>Reference mark 4</td> <td>↘ Measuring probe 2</td> </tr> </tbody> </table>	Function No.	Function for bit 7 = 0 (search for reference mark)	Function for bit 7 = 1 (flying measurement)	1	Reference mark 1	↗ Measuring probe 1	2	Reference mark 2	↘ Measuring probe 1	3	Reference mark 3	↗ Measuring probe 2	4	Reference mark 4	↘ Measuring probe 2
Function No.		Function for bit 7 = 0 (search for reference mark)	Function for bit 7 = 1 (flying measurement)													
1		Reference mark 1	↗ Measuring probe 1													
2		Reference mark 2	↘ Measuring probe 1													
3		Reference mark 3	↗ Measuring probe 2													
4	Reference mark 4	↘ Measuring probe 2														
G1_STW.1																
G1_STW.2																
G1_STW.3																
G1_STW.4	Start/stop/read selected function															
G1_STW.5																

Signal	Description												
G1_STW.6	<table border="1" style="display: inline-table; vertical-align: middle;"> <tr><td>0</td><td>1</td><td>0</td><td>1</td></tr> <tr><td>0</td><td>0</td><td>1</td><td>1</td></tr> <tr><td>0</td><td>0</td><td>0</td><td>0</td></tr> </table> <div style="display: inline-block; vertical-align: middle; margin-left: 10px;"> <p>Interrupt function</p> <p>Read generated value</p> <p>Activate selected function</p> <p>No function</p> </div>	0	1	0	1	0	0	1	1	0	0	0	0
0	1	0	1										
0	0	1	1										
0	0	0	0										
G1_STW.7	Mode of the function to be activated 1 = Flying measurement 0 = Search for reference mark												
G1_STW.8	Reserved												
G1_STW.9	Reserved												
G1_STW.10	Reserved												
G1_STW.11	Reserved												
G1_STW.12	Reserved												
G1_STW.13	1 = Request value cyclic transfer of the absolute position value in Gn_XIST2												
G1_STW.14	1 = Request parking encoder												
G1_STW.15	= Acknowledge encoder fault												

6.3.8 SATZANW control word

Signal	Description
SATZANW.0	1 = Traversing block selection, bit 0
SATZANW.1	1 = Traversing block selection, bit 1
SATZANW.2	1 = Traversing block selection, bit 2
SATZANW.3	1 = Traversing block selection, bit 3
SATZANW.4	1 = Traversing block selection, bit 4
SATZANW.5	1 = Traversing block selection, bit 5
SATZANW.6	Reserved
SATZANW.7	Reserved
SATZANW.8	Reserved
SATZANW.9	Reserved
SATZANW.10	Reserved
SATZANW.11	Reserved
SATZANW.12	Reserved
SATZANW.13	Reserved
SATZANW.14	Reserved
SATZANW.15	1 = Activate MDI 0 = Deactivate MDI

6.3.9 MDI_MOD control word

Signal	Description
MDI_MOD.0	1 = Absolute positioning is selected 0 = Relative positioning is selected
MDI_MOD.1	0 = Absolute positioning through the shortest distance
MDI_MOD.2	1 = Absolute positioning in the positive direction 2 = Absolute positioning in the negative direction 3 = Absolute positioning through the shortest distance
MDI_MOD.3	Reserved
MDI_MOD.4	Reserved
MDI_MOD.5	Reserved
MDI_MOD.6	Reserved
MDI_MOD.7	Reserved
MDI_MOD.8	Reserved
MDI_MOD.9	Reserved
MDI_MOD.10	Reserved
MDI_MOD.11	Reserved
MDI_MOD.12	Reserved
MDI_MOD.13	Reserved
MDI_MOD.14	Reserved
MDI_MOD.15	Reserved

6.3.10 POS_STW control word

Signal	Description
POS_STW.0	1 = Tracking mode active 0 = No tracking mode active
POS_STW.1	1 = Set reference point 0 = Do not set reference point
POS_STW.2	1 = Reference cam active
POS_STW.3	Reserved
POS_STW.4	Reserved
POS_STW.5	1 = Jogging, incremental active 0 = Jogging, velocity active
POS_STW.6	Reserved
POS_STW.7	Reserved
POS_STW.8	Reserved
POS_STW.9	Reserved
POS_STW.10	Reserved
POS_STW.11	Reserved
POS_STW.12	Reserved
POS_STW.13	Reserved
POS_STW.14	Reserved
POS_STW.15	Reserved

Note

If the tracking mode is activated, the position setpoint follows the actual position value, i.e. position setpoint = actual position value.

6.3.11 POS_STW1 positioning control word

Signal	Description
POS_STW1.0	Traversing block selection, bit 0
POS_STW1.1	Traversing block selection, bit 1
POS_STW1.2	Traversing block selection, bit 2
POS_STW1.3	Traversing block selection, bit 3
POS_STW1.4	Traversing block selection, bit 4
POS_STW1.5	Traversing block selection, bit 5
POS_STW1.6	Reserved
POS_STW1.7	Reserved
POS_STW1.8	1 = Absolute positioning is selected 0 = Relative positioning is selected
POS_STW1.9	0 = Absolute positioning through the shortest distance
POS_STW1.10	1 = Absolute positioning/MDI direction selection, positive 2 = Absolute positioning/MDI direction selection, negative 3 = Absolute positioning through the shortest distance
POS_STW1.11	Reserved
POS_STW1.12	1 = Continuous transfer 0 = Activate MDI block change with  of a traversing task (STW1.6)
POS_STW1.13	Reserved
POS_STW1.14	1 = Signal setting-up selected 0 = Signal positioning selected
POS_STW1.15	1 = MDI selection

6.3.12 POS_STW2 positioning control word

Signal	Description
POS_STW2.0	1 = Tracking mode active
POS_STW2.1	1 = Set reference point
POS_STW2.2	1 = Reference cam active
POS_STW2.3	Reserved
POS_STW2.4	Reserved
POS_STW2.5	1 = Jogging, incremental active 0 = Jogging, velocity active
POS_STW2.6	Reserved
POS_STW2.7	Reserved
POS_STW2.8	Reserved
POS_STW2.9	1 = Start the search for reference in the negative direction 0 = Start the search for reference in the positive direction
POS_STW2.10	Reserved
POS_STW2.11	Reserved
POS_STW2.12	Reserved
POS_STW2.13	Reserved
POS_STW2.14	1 = Software limit switch activation
POS_STW2.15	1 = STOP cam active

Note

If the tracking mode is activated, the position setpoint follows the actual position value, i.e. position setpoint = actual position value.

6.4 Status word definition

6.4.1 ZSW1 status word (for telegrams 1, 2, 3, 5)

Signal	Description
ZSW1.0	1 = Ready for servo on
ZSW1.1	1 = Ready for operation
ZSW1.2	1 = Operation enabled
ZSW1.3	1 = Fault present
ZSW1.4	1 = No coast down active (OFF2 inactive)
ZSW1.5	1 = No fast stop active (OFF3 inactive)
ZSW1.6	1 = Switching on inhibited active
ZSW1.7	1 = Alarm present
ZSW1.8	1 = Speed setpoint - actual value deviation within tolerance t_{off}
ZSW1.9	1 = Control requested
ZSW1.10	1 = f or n comparison value reached/exceeded
ZSW1.11	0 = I, M, or P limit reached
ZSW1.12	1 = Open the holding brake
ZSW1.13	1 = No motor overtemperature alarm
ZSW1.14	1 = Motor rotates forwards ($n_{act} \geq 0$) 0 = Motor rotates backwards ($n_{act} < 0$)
ZSW1.15	1 = No alarm, thermal overload, power unit

6.4.2 ZSW2 status word (for telegrams 2, 3, 5)

Signal	Description
ZSW2.0	Reserved
ZSW2.1	Reserved
ZSW2.2	Reserved
ZSW2.3	Reserved
ZSW2.4	Reserved
ZSW2.5	1 = Alarm class bit 0
ZSW2.6	1 = Alarm class bit 1
ZSW2.7	Reserved
ZSW2.8	1 = Traverse to fixed endstop
ZSW2.9	Reserved
ZSW2.10	1 = Pulses enabled
ZSW2.11	Reserved
ZSW2.12	Slave sign-of-life, bit 0
ZSW2.13	Slave sign-of-life, bit 1
ZSW2.14	Slave sign-of-life, bit 2
ZSW2.15	Slave sign-of-life, bit 3

6.4.3 ZSW1 status word (for telegrams 102, 105)

Signal	Description
ZSW1.0	1 = Ready for servo on
ZSW1.1	1 = Ready for operation
ZSW1.2	1 = Operation enabled
ZSW1.3	1 = Fault present

Signal	Description
ZSW1.4	1 = No coast down active (OFF2 inactive)
ZSW1.5	1 = No fast stop active (OFF3 inactive)
ZSW1.6	1 = Switching on inhibited active
ZSW1.7	1 = Alarm present
ZSW1.8	1 = Speed setpoint - actual value deviation within tolerance t_off
ZSW1.9	1 = Control requested
ZSW1.10	1 = f or n comparison value reached/exceeded
ZSW1.11	1 = Alarm class bit 0
ZSW1.12	1 = Alarm class bit 1
ZSW1.13	Reserved
ZSW1.14	1 = Closed-loop torque control active
ZSW1.15	Reserved

6.4.4 ZSW2 status word (for telegrams 102, 105)

Signal	Description
ZSW2.0	Reserved
ZSW2.1	Reserved
ZSW2.2	Reserved
ZSW2.3	Reserved
ZSW2.4	1 = Ramp-function generator inactive
ZSW2.5	1 = Open the holding brake
ZSW2.6	1 = Integrator inhibit, speed controller
ZSW2.7	Reserved
ZSW2.8	1 = Traverse to fixed endstop
ZSW2.9	Reserved
ZSW2.10	Reserved
ZSW2.11	Reserved
ZSW2.12	Slave sign-of-life, bit 0
ZSW2.13	Slave sign-of-life, bit 1
ZSW2.14	Slave sign-of-life, bit 2
ZSW2.15	Slave sign-of-life, bit 3

6.4.5 ZSW1 status word (for telegrams 7, 9, 110, 111)













Signal	Description
ZSW1.0	1 = Ready for switching on
ZSW1.1	1 = Ready for operation (DC link loaded, pulses blocked)
ZSW1.2	1 = Operation enabled (drive follows n_set)
ZSW1.3	1 = Fault present
ZSW1.4	1 = No coast down active (OFF2 inactive)
ZSW1.5	1 = No fast stop active (OFF3 inactive)
ZSW1.6	1 = Switching on inhibited active
ZSW1.7	1 = Alarm present
ZSW1.8	1 = Following error within tolerance
ZSW1.9	1 = Control requested
ZSW1.10	1 = Target position reached
ZSW1.11	1 = Reference point set

Signal	Description
ZSW1.12	 = Acknowledgement traversing block activated
ZSW1.13	1 = Setpoint fixed
ZSW1.14	1 = Axis accelerated
ZSW1.15	1 = Axis decelerated

6.4.6 ZSW2 status word (for telegrams 9, 110, 111)

Signal	Description
ZSW2.0	Reserved
ZSW2.1	Reserved
ZSW2.2	Reserved
ZSW2.3	Reserved
ZSW2.4	Reserved
ZSW2.5	1 = Alarm class bit 0
ZSW2.6	1 = Alarm class bit 1
ZSW2.7	Reserved
ZSW2.8	1 = Traverse to fixed endstop
ZSW2.9	Reserved
ZSW2.10	1 = Pulses enabled
ZSW2.11	Reserved
ZSW2.12	Slave sign-of-life, bit 0
ZSW2.13	Slave sign-of-life, bit 1
ZSW2.14	Slave sign-of-life, bit 2
ZSW2.15	Slave sign-of-life, bit 3

6.4.7 G1_ZSW encoder 1 status word

Signal	Description											
G1_ZSW.0	Feedback signal of the active function (1 = function active)											
G1_ZSW.1	<table border="1"> <thead> <tr> <th>Function No.</th> <th>For reference number and flying measurement</th> </tr> </thead> <tbody> <tr> <td>1</td> <td>Reference mark 1 or measuring probe 1 </td> </tr> <tr> <td>2</td> <td>Reference mark 2 or measuring probe 1 </td> </tr> <tr> <td>3</td> <td>Reference mark 3 or measuring probe 2 </td> </tr> <tr> <td>4</td> <td>Reference mark 4 or measuring probe 2 </td> </tr> </tbody> </table>		Function No.	For reference number and flying measurement	1	Reference mark 1 or measuring probe 1 	2	Reference mark 2 or measuring probe 1 	3	Reference mark 3 or measuring probe 2 	4	Reference mark 4 or measuring probe 2 
Function No.			For reference number and flying measurement									
1			Reference mark 1 or measuring probe 1 									
2			Reference mark 2 or measuring probe 1 									
3	Reference mark 3 or measuring probe 2 											
4	Reference mark 4 or measuring probe 2 											
G1_ZSW.2												
G1_ZSW.3												
G1_ZSW.4	1 = Position actual value from function 1	Generated value in Gn_XIST2 (and can be read)										
G1_ZSW.5	1 = Position actual value from function 2											
G1_ZSW.6	1 = Position actual value from function 3											
G1_ZSW.7	1 = Position actual value from function 4											
G1_ZSW.8	Reserved											
G1_ZSW.9	Reserved											
G1_ZSW.10	Reserved											
G1_ZSW.11	1 = Acknowledge encoder fault active											
G1_ZSW.12	Reserved (for reference point offset)											
G1_ZSW.13	Absolute value is cyclically transferred											
G1_ZSW.14	Parking encoder active											
G1_ZSW.15	Encoder fault, the fault is in Gn_XIST2											

6.4.8 MELDW status word

Signal	Description
MELDW.0	1 = Ramp-up/ramp-down complete 0 = Ramp-function generator active
MELDW.1	1 = Torque utilization [%] < torque threshold value 2
MELDW.2	1 = n_act < speed threshold value 3 (p2161)
MELDW.3	1 = n_act ≤ speed threshold value 2
MELDW.4	1 = Vdc_min controller active
MELDW.5	Reserved
MELDW.6	1 = No motor overtemperature alarm
MELDW.7	1 = No alarm, thermal overload, power unit
MELDW.8	1 = Speed setpoint - actual value deviation within tolerance t_on
MELDW.9	Reserved
MELDW.10	Reserved
MELDW.11	1 = Controller enable
MELDW.12	1 = Drive ready
MELDW.13	1 = Pulses enabled
MELDW.14	Reserved
MELDW.15	Reserved

6.4.9 POS_ZSW1 positioning status word

Signal	Description
POS_ZSW1.0	Active Traversing Block Bit 0 (2 ⁰)
POS_ZSW1.1	Active Traversing Block Bit 0 (2 ¹)
POS_ZSW1.2	Active Traversing Block Bit 0 (2 ²)
POS_ZSW1.3	Active Traversing Block Bit 0 (2 ³)
POS_ZSW1.4	Active Traversing Block Bit 0 (2 ⁴)
POS_ZSW1.5	Active Traversing Block Bit 0 (2 ⁵)
POS_ZSW1.6	Reserved
POS_ZSW1.7	Reserved
POS_ZSW1.8	1 = STOP cam minus active
POS_ZSW1.9	1 = STOP cam plus active
POS_ZSW1.10	1 = Jogging active
POS_ZSW1.11	1 = Reference point approach active
POS_ZSW1.12	Reserved
POS_ZSW1.13	1 = Traversing Block active
POS_ZSW1.14	1 = Set-up active
POS_ZSW1.15	1 = MDI active 0 = MDI inactive

6.4.10 POS_ZSW2 positioning status word

Signal	Description
POS_ZSW2.0	1 = Tracking mode active
POS_ZSW2.1	1 = Velocity limiting active
POS_ZSW2.2	1 = Setpoint available
POS_ZSW2.3	Reserved
POS_ZSW2.4	1 = Axis moves forward

Signal	Description
POS_ZSW2.5	1 = Axis moves backwards
POS_ZSW2.6	1 = Software limit switch minus reached
POS_ZSW2.7	1 = Software limit switch plus reached
POS_ZSW2.8	1 = Position actual value ≤ cam switching position 1
POS_ZSW2.9	1 = Position actual value ≤ cam switching position 2
POS_ZSW2.10	1 = Direct output 1 via traversing block
POS_ZSW2.11	1 = Direct output 2 via traversing block
POS_ZSW2.12	1 = Fixed stop reached
POS_ZSW2.13	1 = Fixed stop clamping torque reached
POS_ZSW2.14	1 = Travel to fixed stop active
POS_ZSW2.15	1 = Traversing command active

For more information about the PROFINET communication, refer to SINAMICS V90, SIMOTICS S-1FL6 Operating Instructions.

7 Parameters

7.1 Overview

The section below lists all the parameters of the SINAMICS V90 PN servo drive.

Parameter number

Numbers prefixed with an "r" indicate that parameter is a read-only parameter.

Numbers prefixed with a "p" indicate that the parameter is an editable parameter.

Effective

Indicates the conditions for making parameterization effective. Two conditions are possible:

- **IM (Immediately)**: Parameter value becomes effective immediately after changing.
- **RE (Reset)**: Parameter value becomes effective after repower-on.

Can be changed

This indicates when the parameter can be changed. Two states are possible:

- **U (Run)**: Can be changed in the "**Running**" state when the drive is in "servo on" state. The "RDY" LED lights up green.
- **T (Ready to run)**: Can be changed in the "**Ready**" state when the drive is in "servo off" state. The "RDY" LED lights up red.

Note

When judging the state of the drive according to the "RDY" LED, ensure that no faults or alarms exist.

Data type

Date type	Abbreviation	Description
Integer16	I16	16-bit integer
Integer32	I32	32-bit integer
Unsigned8	U8	8-bit unsigned integer
Unsigned16	U16	16-bit unsigned integer
Unsigned32	U32	32-bit unsigned integer
FloatingPoint32	Float	32-bit floating point number

Parameter groups

The SINAMICS V90 PN parameters are divided into the following groups:

Parameter group	Available parameters	Parameter group display on the BOP
Basic parameters	p07xx, p10xx to p16xx, p21xx	
Application parameters	p29xxx	
Communication parameters	p09xx, p89xx	
Basic positioner parameters	p25xx, p26xx	
Status monitoring parameters	All read-only parameters	

7.2 Parameter list

Editable parameters

The values of the parameters marked with an asterisk (*) may be changed after commissioning. Make sure you back up the parameters first as required if you desire to replace the motor. The default values of the parameters marked with two asterisks (**) are motor dependent. They may have different default values when the drive connects to different motors.

Par. No.	Name	Min	Max	Factory Setting	Unit	Data type	Effective	Can be changed
p0748	CU invert digital outputs	-	-	0	-	U32	IM	T, U
<p>Description: Inverts the signals at the digital outputs.</p> <ul style="list-style-type: none"> • Bit 0: inverts signal DO 1 <ul style="list-style-type: none"> – Bit 0 = 0: not inverted – Bit 0 = 1: inverted • Bit 1: inverts signal DO 2 <ul style="list-style-type: none"> – Bit 1 = 0: not inverted – Bit 1 = 1: inverted 								
p0922	PROFIdrive: PZD telegram selection	1	111	105	-	U16	IM	T
<p>Description: Sets the send and receive telegram.</p> <p>For speed control mode:</p> <ul style="list-style-type: none"> • 1: Standard telegram 1, PZD-2/2 • 2: Standard telegram 2, PZD-4/4 • 3: Standard telegram 3, PZD-5/9 • 5: Standard telegram 5, PZD-9/9 • 102: SIEMENS telegram 102, PZD-6/10 • 105: SIEMENS telegram 105, PZD-10/10 <p>For basic positioner control mode:</p> <ul style="list-style-type: none"> • 7: Standard telegram 7, PZD-2/2 • 9: Standard telegram 9, PZD-10/5 • 110: SIEMENS telegram 110, PZD-12/7 • 111: SIEMENS telegram 111, PZD-12/12 								

Par. No.	Name	Min	Max	Factory Setting	Unit	Data type	Effective	Can be changed
p0925	PROFIdrive: Synchronous sign-of-life tolerance	0	65535	1	-	U16	IM	T, U
	Description: Sets the number of tolerated consecutive sign-of-life errors of the clock-cycle synchronous master. The sign-of-life signal is normally received in PZD4 (control word 2) from the master.							
p0972	Drive unit reset	0	2	0	-	U16	IM	T, U
	Description: Sets the required procedure to execute a hardware reset for the drive unit.							
	<ul style="list-style-type: none"> • 0: Inactive • 1: Hardware reset immediate • 2: Hardware reset preparation 							
	Danger: It must be absolutely ensured that the system is in a safe condition. The memory card/device memory of the Control Unit must not be accessed.							
	Note: If value = 1: Reset is immediately executed and communications interrupted. If value = 2: Help to check the reset operation. Firstly, set p0972 = 2 and then read back. Secondly, set p0972 = 1 (it is possible that this request is possibly no longer acknowledged). The communication is then interrupted. After the drive unit has been restarted and communications have been established, read p0972 and check the following: p0972 = 0? → The reset was successfully executed. p0972 > 0? → The reset was not executed.							
p0977	Save all parameters	0	1	0	-	U16	IM	T, U
	Description: Saves all parameters of the drive system to the non-volatile memory. When saving, only the adjustable parameters intended to be saved are taken into account.							
	<ul style="list-style-type: none"> • Value = 0: Inactive • Value = 1: Save in non-volatile memory - downloaded at POWER ON Notice: The Control Unit power supply may only be powered down after data has been saved (i.e. after data save has been started, wait until the parameter again has the value 0). Writing to parameters is inhibited while saving.							
p1058	JOG 1 speed setpoint	0.00	210000.000	100.00	rpm	Float	IM	T
	Description: Sets the speed/velocity for JOG 1. Jogging is level-triggered and allows the motor to be incrementally moved.							
	Note: The parameter values displayed on the BOP are integers.							
p1082 *	Maximum speed	0.000	210000.000	1500.00 0	rpm	Float	IM	T
	Description: Sets the highest possible speed.							
	Notice: After the value has been modified, no further parameter modifications can be made.							
	Note: The parameter values displayed on the BOP are integers. The parameter applies for both motor directions. The parameter has a limiting effect and is the reference quantity for all ramp-up and ramp-down times (e.g. down ramps, ramp-function generator and motor potentiometer). The range of the parameter is different when connect with different motors.							
p1083 *	Speed limit in positive direction of rotation	0.000	210000.000	210000.000	rpm	Float	IM	T, U
	Description: Sets the maximum speed for the positive direction.							
	Note: The parameter values displayed on the BOP are integers.							

Par. No.	Name	Min	Max	Factory Setting	Unit	Data type	Effective	Can be changed
p1086 *	Speed limit in negative direction of rotation	-210000.000	0.000	-210000.000	rpm	Float	IM	T, U
	Description: Sets the speed limit for the negative direction.							
	Note: The parameter values displayed on the BOP are integers.							
p1115	Ramp-function generator selection	0	1	0	-	I16	IM	T
	Description: Sets the ramp-function generator type.							
	Note: Another ramp-function generator type can only be selected when the motor is at a standstill.							
p1120	Ramp-function generator ramp-up time	0.000	999999.000	1	s	Float	IM	T, U
	Description: The ramp-function generator ramps-up the speed setpoint from standstill (setpoint = 0) up to the maximum speed (p1082) in this time.							
	Dependency: Refer to p1082							
p1121	Ramp-function generator ramp-down time	0.000	999999.000	1	s	Float	IM	T, U
	Description: Sets the ramp-down time for the ramp-function generator.							
	The ramp-function generator ramps-down the speed setpoint from the maximum speed (p1082) down to standstill (setpoint = 0) in this time.							
	Further, the ramp-down time is always effective for OFF1.							
Dependency: Refer to p1082								
p1130	Ramp-function generator initial rounding-off time	0.000	30.000	0.000	s	Float	IM	T, U
	Description: Sets the initial rounding-off time for the extended ramp generator. The value applies to ramp-up and ramp-down.							
	Note: Rounding-off times avoid an abrupt response and prevent damage to the mechanical system.							
p1131	Ramp-function generator final rounding-off time	0.000	30.000	0.000	s	Float	IM	T, U
	Description: Sets the final rounding-off time for the extended ramp generator. The value applies to ramp-up and ramp-down.							
	Note: Rounding-off times avoid an abrupt response and prevent damage to the mechanical system.							
p1135	OFF3 ramp-down time	0	600	0	s	Float	IM	T, U
	Description: Sets the ramp-down time from the maximum speed down to zero speed for the OFF3 command.							
	Note: This time can be exceeded if the DC link voltage reaches its maximum value.							
p1215 *	Motor holding brake configuration	0	2	0	-	I16	IM	T
	Description: Sets the holding brake configuration.							
	Dependency: Refer to p1216, p1217, p1226, p1227, p1228							
	Caution: For the setting p1215 = 0, if a brake is used, it remains closed. If the motor moves, this will destroy the brake.							
	Notice: If p1215 was set to 1, then when the pulses are suppressed, the brake is closed even if the motor is still rotating.							
Note: The parameter can only be set to zero when the pulses are inhibited.								

Par. No.	Name	Min	Max	Factory Setting	Unit	Data type	Effective	Can be changed
p1216 *	Motor holding brake opening time	0	10000	100	ms	Float	IM	T, U
	<p>Description: Sets the time to open the motor holding brake. After controlling the holding brake (opens), the speed/velocity setpoint remains at zero for this time. After this, the speed/velocity setpoint is enabled.</p>							
	<p>Dependency: Refer to p1215, p1217</p>							
	<p>Note: For a motor with integrated brake, this time is pre-assigned the value saved in the motor. For p1216 = 0 ms, the monitoring and the message A7931 "Brake does not open" are deactivated.</p>							
p1217 *	Motor holding brake closing time	0	10000	100	ms	Float	IM	T, U
	<p>Description: Sets the time to apply the motor holding brake. After OFF1 or OFF3 and the holding brake is controlled (the brake closes), then the drive remains closed-loop controlled for this time stationary with a speed setpoint/velocity setpoint of zero. The pulses are suppressed when the time expires.</p>							
	<p>Dependency: Refer to p1215, p1216</p>							
	<p>Note: For a motor with integrated brake, this time is pre-assigned the value saved in the motor. For p1217 = 0 ms, the monitoring and the message A07932 "Brake does not close" are deactivated.</p>							
p1226	Threshold for zero speed detection	0.00	210000.00	20.00	rpm	Float	IM	T, U
	<p>Description: Sets the speed threshold for the standstill identification. Acts on the actual value and setpoint monitoring. When braking with OFF1 or OFF3, when the threshold is undershot, standstill is identified. The following applies when the brake control is activated: When the threshold is undershot, the brake control is started and the system waits for the brake closing time in p1217. The pulses are then suppressed. If the brake control is not activated, the following applies: When the threshold is undershot, the pulses are suppressed and the drive coasts down.</p>							
	<p>Dependency: Refer to p1215, p1216, p1217, p1227</p>							
	<p>Notice: For reasons relating to the compatibility to earlier firmware versions, a parameter value of zero in indices 1 to 31 is overwritten with the parameter value in index 0 when the drive boots.</p>							
	<p>Note: Standstill is identified in the following cases: - The speed actual value falls below the speed threshold in p1226 and the time started after this in p1228 has expired. - The speed setpoint falls below the speed threshold in p1226 and the time started after this in p1227 has expired. The actual value sensing is subject to measuring noise. For this reason, standstill cannot be detected if the speed threshold is too low.</p>							
	<p>Dependency: Refer to p1215, p1216, p1217, p1226</p>							
p1227	Zero speed detection monitoring time	0.000	300.000	300.000	s	Float	IM	T, U
	<p>Description: Sets the monitoring time for the standstill identification. When braking with OFF1 or OFF3, standstill is identified after this time has expired, after the setpoint speed has fallen below p1226. After this, the brake control is started, the system waits for the closing time in p1217 and then the pulses are suppressed.</p>							
	<p>Dependency: Refer to p1215, p1216, p1217, p1226</p>							
	<p>Notice: The setpoint is not equal to zero dependent on the selected value. This can therefore cause the monitoring time in p1227 to be exceeded. In this case, for a driven motor, the pulses are not suppressed..</p>							

Par. No.	Name	Min	Max	Factory Setting	Unit	Data type	Effective	Can be changed
	<p>Note: Standstill is identified in the following cases:</p> <ul style="list-style-type: none"> - The speed actual value falls below the speed threshold in p1226 and the time started after this in p1228 has expired. - The speed setpoint falls below the speed threshold in p1226 and the time started after this in p1227 has expired. <p>For p1227 = 300.000 s, the following applies: Monitoring is de-activated.</p> <p>For p1227 = 0.000 s, the following applies: With OFF1 or OFF3 and a ramp-down time = 0, the pulses are immediately suppressed and the motor "coasts" down.</p>							
p1228	Pulse suppression delay time	0.000	299.000	0.000	s	Float	IM	T, U
	<p>Description: Sets the delay time for pulse suppression. After OFF1 or OFF3, the pulses are canceled, if at least one of the following conditions is fulfilled:</p> <ul style="list-style-type: none"> - The speed actual value falls below the threshold in p1226 and the time started after this in p1228 has expired. - The speed setpoint falls below the threshold in p1226 and the time started after this in p1227 has expired. <p>Dependency: Refer to p1226, p1227</p> <p>Notice: When the motor holding brake is activated, pulse cancellation is additionally delayed by the brake closing time (p1217).</p>							
p1414	Speed setpoint filter activation	-	-	0000 bin	-	U16	IM	T, U
	<p>Description: Setting for activating/de-activating the speed setpoint filter.</p> <ul style="list-style-type: none"> • Bit 0: Activate filter 1 <ul style="list-style-type: none"> - Bit 0 = 0: Deactivated - Bit 0 = 1: Activated • Bit 1: Activate filter 2 <ul style="list-style-type: none"> - Bit 1 = 0: Deactivated - Bit 1 = 1: Activated <p>Dependency: The individual speed setpoint filters are parameterized as of p1415.</p> <p>Note: The drive unit displays the value in hex format. To know the logic (high/low) assignment to each bit, you must convert the hex number to the binary number, for example, FF (hex) = 11111111 (bin).</p>							
p1415	Speed setpoint filter 1 type	0	2	0	-	I16	IM	T, U
	<p>Description: Sets the type for speed setpoint filter 1.</p> <p>Dependency: PT1 low pass: p1416 PT2 low pass: p1417, p1418 General filter: p1417 ... p1420</p>							
p1416	Speed setpoint filter 1 time constant	0.00	5000.00	0.00	ms	Float	IM	T, U
	<p>Description: Sets the time constant for the speed setpoint filter 1 (PT1).</p> <p>Dependency: Refer to p1414, p1415</p> <p>Note: This parameter is only effective if the filter is set as a PT1 low pass.</p>							

Par. No.	Name	Min	Max	Factory Setting	Unit	Data type	Effective	Can be changed
p1417	Speed setpoint filter 1 denominator natural frequency	0.5	16000.0	1999.0	Hz	Float	IM	T, U
	Description: Sets the denominator natural frequency for speed setpoint filter 1(PT2, general filter).							
	Dependency: Refer to p1414, p1415							
	Note: This parameter is only effective if the speed filter is parameterized as a PT2 low pass or as general filter. The filter is only effective if the natural frequency is less than half of the sampling frequency.							
p1418	Speed setpoint filter 1 denominator damping	0.001	10.000	0.700	-	Float	IM	T, U
	Description: Sets the denominator damping for speed setpoint filter 1 (PT2, general filter).							
	Dependency: Refer to p1414, p1415							
	Note: This parameter is only effective if the speed filter is parameterized as a PT2 low pass or as general filter.							
p1419	Speed setpoint filter 1 numerator natural frequency	0.5	16000.0	1999.0	Hz	Float	IM	T, U
	Description: Sets the numerator natural frequency for speed setpoint filter 1 (general filter).							
	Dependency: Refer to p1414, p1415							
	Note: This parameter is only effective if the speed filter is set as a general filter. The filter is only effective if the natural frequency is less than half of the sampling frequency.							
p1420	Speed setpoint filter 1 numerator damping	0.001	10.000	0.700	-	Float	IM	T, U
	Description: Sets the numerator damping for speed setpoint filter 1 (general filter).							
	Dependency: Refer to p1414, p1415							
	Note: This parameter is only effective if the speed filter is set as a general filter.							
p1421	Speed setpoint filter 2 type	0	2	0	-	16	IM	T, U
	Description: Sets the type for speed setpoint filter 2.							
	Dependency: PT1 low pass: p1422 PT2 low pass: p1423, p1424 General filter: p1423 ... p1426							
p1422	Speed setpoint filter 2 time constant	0.00	5000.00	0.00	ms	Float	IM	T, U
	Description: Sets the time constant for the speed setpoint filter 2 (PT1).							
	Dependency: Refer to p1414, p1421							
	Note: This parameter is only effective if the speed filter is set as a PT1 low pass.							
p1423	Speed setpoint filter 2 denominator natural frequency	0.5	16000.0	1999.0	Hz	Float	IM	T, U
	Description: Sets the denominator natural frequency for speed setpoint filter 2 (PT2, general filter).							
	Dependency: Refer to p1414, p1421							
	Note: This parameter is only effective if the speed filter is parameterized as a PT2 low pass or as general filter. The filter is only effective if the natural frequency is less than half of the sampling frequency.							

Par. No.	Name	Min	Max	Factory Setting	Unit	Data type	Effective	Can be changed
p1424	Speed setpoint filter 2 denominator damping	0.001	10.000	0.700	-	Float	IM	T, U
	Description: Sets the denominator damping for speed setpoint filter 2 (PT2, general filter).							
	Dependency: Refer to p1414, p1421							
Note: This parameter is only effective if the speed filter is parameterized as a PT2 low pass or as general filter.								
p1425	Speed setpoint filter 2 numerator natural frequency	0.5	16000.0	1999.0	Hz	Float	IM	T, U
	Description: Sets the numerator natural frequency for speed setpoint filter 2 (general filter).							
	Dependency: Refer to p1414, p1421							
Note: This parameter is only effective if the speed filter is set as a general filter. The filter is only effective if the natural frequency is less than half of the sampling frequency.								
p1426	Speed setpoint filter 2 numerator damping	0.000	10.000	0.700	-	Float	IM	T, U
	Description: Sets the numerator damping for speed setpoint filter 2 (general filter).							
	Dependency: Refer to p1414, p1421							
Note: This parameter is only effective if the speed filter is set as a general filter.								
p1441	Actual speed smoothing time	0.00	50.00	0.00	ms	Float	IM	T, U
	Description: Sets the smoothing time constant (PT1) for the speed actual value.							
	Note: The speed actual value should be smoothed for increment encoders with a low pulse number. After this parameter has been changed, we recommend that the speed controller is adapted and/or the speed controller settings checked Kp (p29120) and Tn (p29121).							
p1520 *	Torque limit upper	-1000000.00	2000000.00	0.00	Nm	Float	IM	T, U
	Description: Sets the fixed upper torque limit.							
	Danger: Negative values when setting the upper torque limit (p1520 < 0) can result in the motor accelerating in an uncontrollable fashion.							
Notice: The maximum value depends on the maximum torque of the connected motor.								
p1521 *	Torque limit lower	-2000000.00	1000000.00	0.00	Nm	Float	IM	T, U
	Description: Sets the fixed lower torque limit.							
	Danger: Positive values when setting the lower torque limit (p1521 > 0) can result in the motor accelerating in an uncontrollable fashion.							
Notice: The maximum value depends on the maximum torque of the connected motor.								
p1656 *	Activates current setpoint filter	-	-	0001 bin	-	U16	IM	T, U
	Description: Setting for activating/de-activating the current setpoint filter. <ul style="list-style-type: none"> • Bit 0: Activate filter 1 <ul style="list-style-type: none"> – Bit 0 = 0: Deactivated – Bit 0 = 1: Activated • Bit 1: Activate filter 2 <ul style="list-style-type: none"> – Bit 1 = 0: Deactivated – Bit 1 = 1: Activated • Bit 2: Activate filter 3 <ul style="list-style-type: none"> – Bit 2 = 0: Deactivated – Bit 2 = 1: Activated • Bit 3: Activate filter 4 <ul style="list-style-type: none"> – Bit 3 = 0: Deactivated – Bit 3 = 1: Activated 							

Par. No.	Name	Min	Max	Factory Setting	Unit	Data type	Effective	Can be changed
	<p>Dependency: The individual current setpoint filters are parameterized as of p1658.</p> <p>Note: If not all of the filters are required, then the filters should be used consecutively starting from filter 1. The drive unit displays the value in hex format. To know the logic (high/low) assignment to each bit, you must convert the hex number to the binary number, for example, FF (hex) = 11111111 (bin).</p>							
p1658 *	Current setpoint filter 1 denominator natural frequency	0.5	16000.0	1999.0	Hz	Float	IM	T, U
	<p>Description: Sets the denominator natural frequency for current setpoint filter 1 (PT2, general filter).</p> <p>Dependency: The current setpoint filter 1 is activated via p1656.0 and parameterized via p1658 ... p1659.</p>							
p1659 *	Current setpoint filter 1 denominator damping	0.001	10.000	0.700	-	Float	IM	T, U
	<p>Description: Sets the denominator damping for current setpoint filter 1.</p> <p>Dependency: The current setpoint filter 1 is activated via p1656.0 and parameterized via p1658 ... p1659.</p>							
p1663	Current setpoint filter 2 denominator natural frequency	0.5	16000.0	1000.0	Hz	Float	IM	T, U
	<p>Description: Sets the denominator natural frequency for current setpoint filter 2 (PT2, general filter).</p> <p>Dependency: Current setpoint filter 2 is activated via p1656.1 and parameterized via p1663 ... p1666.</p>							
p1664	Current setpoint filter 2 denominator damping	0.001	10.000	0.300	-	Float	IM	T, U
	<p>Description: Sets the denominator damping for current setpoint filter 2.</p> <p>Dependency: Current setpoint filter 2 is activated via p1656.1 and parameterized via p1663 ... p1666.</p>							
p1665	Current setpoint filter 2 numerator natural frequency	0.5	16000.0	1000.0	Hz	Float	IM	T, U
	<p>Description: Sets the numerator natural frequency for current setpoint filter 2 (general filter).</p> <p>Dependency: Current setpoint filter 2 is activated via p1656.1 and parameterized via p1662 ... p1666.</p>							
p1666	Current setpoint filter 2 numerator damping	0.000	10.000	0.010	-	Float	IM	T, U
	<p>Description: Sets the numerator damping for current setpoint filter 2.</p> <p>Dependency: Current setpoint filter 2 is activated via p1656.1 and parameterized via p1663 ... p1666.</p>							
p1668	Current setpoint filter 3 denominator natural frequency	0.5	16000.0	1000.0	Hz	Float	IM	T, U
	<p>Description: Sets the denominator natural frequency for current setpoint filter 3 (PT2, general filter).</p> <p>Dependency: Current setpoint filter 3 is activated via p1656.2 and parameterized via p1668 ... p1671.</p>							
p1669	Current setpoint filter 3 denominator damping	0.001	10.000	0.300	-	Float	IM	T, U
	<p>Description: Sets the denominator damping for current setpoint filter 3.</p> <p>Dependency: Current setpoint filter 3 is activated via p1656.2 and parameterized via p1668 ... p1671.</p>							
p1670	Current setpoint filter 3 numerator natural frequency	0.5	16000.0	1000.0	Hz	Float	IM	T, U
	<p>Description: Sets the numerator natural frequency for current setpoint filter 3 (general filter).</p> <p>Dependency: Current setpoint filter 3 is activated via p1656.2 and parameterized via p1668 ... p1671.</p>							
p1671	Current setpoint filter 3 numerator damping	0.000	10.000	0.010	-	Float	IM	T, U
	<p>Description: Sets the numerator damping for current setpoint filter 3.</p> <p>Dependency: Current setpoint filter 3 is activated via p1656.2 and parameterized via p1668 ... p1671.</p>							

Par. No.	Name	Min	Max	Factory Setting	Unit	Data type	Effective	Can be changed
p1673	Current setpoint filter 4 denominator natural frequency	0.5	16000.0	1000.0	Hz	Float	IM	T, U
	Description: Sets the denominator natural frequency for current setpoint filter 4 (PT2, general filter).							
	Dependency: Current setpoint filter 4 is activated via p1656.3 and parameterized via p1673 ... p1675.							
p1674	Current setpoint filter 4 denominator damping	0.001	10.000	0.300	-	Float	IM	T, U
	Description: Sets the denominator damping for current setpoint filter 4.							
	Dependency: Current setpoint filter 4 is activated via p1656.3 and parameterized via p1673 ... p1675.							
p1675	Current setpoint filter 4 numerator natural frequency	0.5	16000.0	1000.0	Hz	Float	IM	T, U
	Description: Sets the numerator natural frequency for current setpoint filter 4 (general filter).							
	Dependency: Current setpoint filter 4 is activated via p1656.3 and parameterized via p1673 ... p1675.							
p1676	Current setpoint filter 4 numerator damping	0.000	10.000	0.010	-	Float	IM	T, U
	Description: Sets the numerator damping for current setpoint filter 4.							
	Dependency: Current setpoint filter 4 is activated via p1656.3 and parameterized via p1673 ... p1675.							
p2000	Reference speed	6.00	210000.00	3000.00	rpm	Float	IM	T
	Description: Sets the reference quantity for speed and frequency. All speeds or frequencies specified as relative value are referred to this reference quantity. The reference quantity corresponds to 100% or 4000 hex (word) or 40000000 hex (double word).							
	Dependency: Refer to: p2003							
p2002	Reference current	0.10	100000.00	100.00	Arms	Float	IM	T
	Description: Sets the reference quantity for currents. All currents specified as relative value are referred to this reference quantity. The reference quantity corresponds to 100% or 4000 hex (word) or 4000 0000 hex (double word).							
	Notice: If various DDS are used with different motor data, then the reference quantities remain the same as these are not changed over with the DDS. The resulting conversion factor should be taken into account (e.g. for trace records). Example: p2002 = 100 A Reference quantity 100 A corresponds to 100 %							
p2003	Reference torque	0.01	20000000.00	1.00	Nm	Float	IM	T
	Description: Sets the reference quantity for torque. All torques specified as relative value are referred to this reference quantity. The reference quantity corresponds to 100% or 4000 hex (word) or 40000000 hex (double word).							
p2118[0...19]	Message number selection of a type-to-be-changed message	0	65535	[0] 6310 [1] 7594 [2] 7566 [3] 32905 [4...19] 0	-	U16	IM	T, U
	Description: Selects faults or alarms of whose message type should be changed.							

Par. No.	Name	Min	Max	Factory Setting	Unit	Data type	Effective	Can be changed
	<p>Dependency: Selects the fault or alarm and sets the required type of message realized under the same index. Refer to: p2119</p> <p>Note: Re-parameterization is also possible if a message is present. The change only becomes effective after the message has gone.</p>							
p2119[0...19]	Change the type for a message	1	3	[0] 2 [1...3] 3 [4...19] 1	-	16	IM	T, U
	<p>Description: Sets the message type for the selected fault or alarm.</p> <ul style="list-style-type: none"> Value = 1: Fault (F) Value = 2: Alarm (A) Value = 3: No message (N) <p>Dependency: Selects the fault or alarm and sets the required type of message realized under the same index. Refer to: p2118</p> <p>Note: Re-parameterization is also possible if a message is present. The change only becomes effective after the message has gone. The message type can only be changed for messages with the appropriate identification (exception, value = 0).</p> <p>Example: F12345(A): Fault F12345 can be changed to alarm A12345.</p>							
p2153	Speed actual value filter time constant	0	1000000	0	ms	Float	IM	T, U
	<p>Description: Sets the time constant of the PT1 element to smooth the speed/velocity actual value. The smoothed actual speed/velocity is compared with the threshold values and is only used for messages and signals.</p>							
p2161 *	Speed threshold 3	0.00	210000.00	10.00	rpm	Float	IM	T, U
	<p>Description: Sets the speed threshold value for the signal that indicates the axis is stationary.</p>							
p2162 *	Hysteresis speed n_act > n_max	0.00	60000.00	0.00	rpm	Float	IM	T, U
	<p>Description: Sets the hysteresis speed (bandwidth) for the signal "n_act > n_max".</p> <p>Note: For a negative speed limit, the hysteresis is effective below the limit value and for a positive speed limit above the limit value. If significant overshoot occurs in the maximum speed range (for example, due to load shedding), you are advised to increase the dynamic response of the speed controller (if possible). If this is insufficient, the hysteresis p2162 can be increased, but its value must not be greater than the value calculated by the formula below when the motor maximum speed is sufficiently greater than the maximum speed p1082. $p2162 \leq 1.05 \times \text{motor maximum speed} - \text{maximum speed (p1082)}$ The range of the parameter is different when connect with different motors.</p>							
p2175 *	Motor blocked speed threshold	0.00	210000.00	210000.00	rpm	Float	IM	T, U
	<p>Description: Sets the speed threshold for the message "Motor blocked".</p> <p>Dependency: Refer to p2177.</p>							
p2177 *	Motor blocked delay time	0.000	65.000	0.500	s	Float	IM	T, U
	<p>Description: Sets the delay time for the message "Motor blocked".</p> <p>Dependency: Refer to p2175.</p>							

Par. No.	Name	Min	Max	Factory Setting	Unit	Data type	Effective	Can be changed
p2525	LR encoder adjustment offset	0	4294967295	0	LU	U32	IM	T
	Description: Position offset when adjusting the absolute encoder.							
	Note: The position offset is only relevant for absolute encoders. The drive determines the value when adjusting the absolute encoder and the user should not change it.							
p2533	LR position setpoint filter time constant	0.00	1000.00	0.00	ms	Float	IM	T, U
	Description: Sets the time constant for the position setpoint filter (PT1).							
	Note: The effective Kv factor (position loop gain) is reduced with the filter. This allows a softer control behavior with improved tolerance with respect to noise/disturbances. Applications: - Reduces the pre-control dynamic response. - Jerk limiting.							
p2542 *	LR standstill window	0	2147483647	1000	LU	U32	IM	T, U
	Description: Sets the standstill window for the standstill monitoring function. After the standstill monitoring time expires, it is cyclically checked whether the difference between the setpoint and actual position is located within the standstill window and, if required, an appropriate fault is output. Value = 0: The standstill monitoring is deactivated.							
	Dependency: Refer to: p2543, p2544, and F07450							
	Note: The following applies for the setting of the standstill and positioning window: Standstill window (p2542) ≥ positioning window (p2544)							
p2543 *	LR standstill monitoring time	0.00	100000.00	200.00	ms	Float	IM	T, U
	Description: Sets the standstill monitoring time for the standstill monitoring function. After the standstill monitoring time expires, it is cyclically checked whether the difference between the setpoint and actual position is located within the standstill window and, if required, an appropriate fault is output.							
	Dependency: Refer to: p2542, p2545, and F07450							
	Note: The following applies for the setting of the standstill and positioning monitoring time: Standstill monitoring time (p2543) ≤ positioning monitoring time (p2545)							
p2544 *	LR positioning window	0	2147483647	40	LU	U32	IM	T, U
	Description: Sets the positioning window for the positioning monitoring function. After the positioning monitoring time expires, it is checked once as to whether the difference between the setpoint and actual position lies within the positioning window and if required an appropriate fault is output. Value = 0: The positioning monitoring function is de-activated.							
	Dependency: Refer to: p2542, p2545, and F07451							
	Note: The following applies for the setting of the standstill and positioning window: Standstill window (p2542) ≥ positioning window (p2544)							
p2545 *	LR positioning monitoring time	0.00	100000.00	1000.00	ms	Float	IM	T, U
	Description: Sets the positioning monitoring time for the positioning monitoring. After the positioning monitoring time expires, it is checked once as to whether the difference between the setpoint and actual position lies within the positioning window and if required an appropriate fault is output.							
	Dependency: The range of p2545 depends on p2543. Refer to: p2543, p2544, and F07451							
	Note: The following applies for the setting of the standstill and positioning monitoring time: Standstill monitoring time (p2543) ≤ positioning monitoring time (p2545)							

Par. No.	Name	Min	Max	Factory Setting	Unit	Data type	Effective	Can be changed
p2546 *	LR dynamic following error monitoring tolerance	0	2147483647	3000	LU	U32	IM	T, U
	Description: Sets the tolerance for the dynamic following error monitoring. If the dynamic following error (r2563) exceeds the selected tolerance, then an appropriate fault is output. Value = 0: The dynamic following error monitoring is deactivated.							
	Dependency: Refer to: r2563, F07452							
	Note: The tolerance bandwidth is intended to prevent the dynamic following error monitoring incorrectly responding due to operational control sequences (e.g. during load surges).							
p2571	IPOS maximum velocity	1	40000000	30000	100 0 LU/ min	U32	IM	T, U
	Description: Sets the maximum velocity for the "basic positioner" function (EPOS).							
	Note: The maximum velocity is active in all of the operating modes of the basic positioner. The maximum velocity for the basic positioner should be aligned with the maximum speed/velocity of the speed/velocity controller: $p2571[1000 \text{ LU/min}] = \text{max_speed[rpm]} \times p29248/p29249 \times p29247/1000$							
p2572 **	EPOS maximum acceleration	1	2000000	100	100 0 LU/s ²	U32	IM	T
	Description: Sets the maximum acceleration for the "basic positioner" function (EPOS).							
	Dependency: Refer to: p2619							
	Note: The maximum acceleration appears to exhibit jumps (without jerk). "Traversing blocks" operating mode: The programmed acceleration override (p2619) acts on the maximum acceleration. "Direct setpoint input/MDI" mode: The acceleration override is effective (p2644, 4000 hex = 100%). "Jog" and "search for reference" modes: No acceleration override is active. The axis starts with the maximum acceleration.							
p2573 **	EPOS maximum deceleration	1	2000000	100	100 0 LU/s ²	U32	IM	T
	Description: Sets the maximum deceleration for the "basic positioner" function (EPOS).							
	Dependency: Refer to: p2620							
	Note: The maximum deceleration appears to exhibit jumps (without jerk). "Traversing blocks" operating mode: The programmed deceleration override (p2620) acts on the maximum deceleration. "Direct setpoint input/MDI" mode: The deceleration override is effective (p2645, 4000 hex = 100%). "Jog" and "search for reference" modes: No deceleration override is effective. The axis brakes with the maximum deceleration.							
p2574 **	EPOS jerk limiting	1	100000000	200000 0	100 0 LU/s ³	U32	IM	T, U
	Description: Sets the jerk limiting.							
	Dependency: Refer to p2572, p2573, and p2575							
	Note: The jerk limiting is internally converted into a jerk time as follows: $\text{Jerk time } T_r = \max(p2572, p2573)/p2574$							

Par. No.	Name	Min	Max	Factory Setting	Unit	Data type	Effective	Can be changed
p2575	EPOS jerk limiting activation	0	1	0	-	U32	IM	T
	Description: Activates the jerk limiting. <ul style="list-style-type: none"> • 0: The jerk limiting is deactivated. • 1: The jerk limiting is activated. 							
	Dependency: Refer to p2574							
p2580	EPOS software limit switch minus	-2147482648	2147482647	-2147482648	LU	I32	IM	T, U
	Description: Sets the software limit switch in the negative direction of travel.							
	Dependency: Refer to p2581, p2582							
p2581	EPOS software limit switch plus	-2147482648	2147482647	2147482647	LU	I32	IM	T, U
	Description: Sets the software limit switch in the positive direction of travel.							
	Dependency: Refer to p2580, p2582							
p2582	EPOS software limit switch activation	-	-	0	-	U32/Binary	IM	T
	Description: Sets the signal source to activate the "software limit switch".							
	Dependency: Refer to p2580, p2581							
	Caution: Software limit switch effective: - Axis is referenced. Software limit switch ineffective: - Modulo correction active. - Search for reference is executed.							
	Notice: Target position for relative positioning outside software limit switch: The traversing block is started and the axis comes to a standstill at the software limit switch. An appropriate alarm is output and the traversing block is interrupted. Traversing blocks with valid position can be activated. Target position for absolute positioning outside software limit switch: In the "traversing blocks" mode, the traversing block is not started and an appropriate fault is output. Axis outside the valid traversing range: If the axis is already outside the valid traversing range, then an appropriate fault is output. The fault can be acknowledged at standstill. Traversing blocks with valid position can be activated.							
	Note: The traversing range can also be limited using STOP cams.							
p2583	EPOS backlash compensation	-200000	200000	0	LU	I32	IM	T, U
	Description: Sets the amount of play (backlash) for positive or negative play. <ul style="list-style-type: none"> • = 0: The backlash compensation is deactivated. • > 0: Positive backlash (normal case) When the direction is reversed, the encoder actual value leads the actual value.							
	<ul style="list-style-type: none"> • < 0: Negative backlash When the direction is reversed, the actual value leads the encoder actual value.							
	Dependency: If a stationary axis is referenced by setting the reference point, or an adjusted with absolute encoder is powered up, then the setting of p2604 is relevant for entering the compensation value. p2604 = 1: Traveling in the positive direction -> A compensation value is immediately entered. Traveling in the negative direction -> A compensation value is not entered p2604 = 0: Traveling in the positive direction -> A compensation value is not entered Traveling in the negative direction -> A compensation value is immediately entered. When again setting the reference point (a referenced axis) or for "flying referencing", p2604 is not relevant but instead the history of the axis. Refer to: p2604							

Par. No.	Name	Min	Max	Factory Setting	Unit	Data type	Effective	Can be changed
p2585	EPOS jog 1 setpoint velocity	-40000000	40000000	-300	100 0 L U/mi n	I32	IM	T, U
	Description: Sets the setpoint speed for jog 1.							
	Dependency: Refer to: p2587							
p2586	EPOS jog 2 setpoint velocity	-40000000	40000000	300	100 0 L U/mi n	I32	IM	T, U
	Description: Sets the setpoint speed for jog 2.							
	Dependency: Refer to: p2588							
p2587	EPOS jog 1 traversing distance	0	214748264 7	1000	LU	U32	IM	T, U
	Description: Sets the traversing distance for incremental jog 1.							
	Dependency: Refer to: p2585							
p2588	EPOS jog 2 traversing distance	0	214748264 7	1000	LU	U32	IM	T, U
	Description: Sets the traversing distance for incremental jog 2.							
	Dependency: Refer to: p2586							
p2599	EPOS reference point coordinate value	-2147482648	214748264 7	0	LU	I32	IM	T, U
	Description: Sets the position value for the reference point coordinate. This value is set as the actual axis position after referencing or adjustment.							
	Dependency: Refer to: p2525							
p2600	EPOS search for reference point offset	-2147482648	214748264 7	0	LU	I32	IM	T, U
	Description: Sets the reference point offset for search for reference.							
p2604	EPOS search for reference start direction	-	-	0	-	U32/Binary	IM	T
	Description: Sets the signal sources for the start direction of the search for reference.							
	<ul style="list-style-type: none"> • 1 signal: Start in the negative direction. • 0 signal: Start in the positive direction. 							
Dependency: Refer to p2583								
p2605	EPOS search for reference approach velocity reference cam	1	40000000	5000	100 0 L U/mi n	U32	IM	T, U
	Description: Sets the approach velocity to the reference cam for the search for reference.							
	Dependency: The search for reference only starts with the approach velocity to the reference cam when there is a reference cam. Refer to: p2604, p2606							
	Note: When traversing to the reference cam, the velocity override is effective. If, at the start of the search for reference, the axis is already at the reference cam, then the axis immediately starts to traverse to the zero mark.							
p2606	EPOS search for reference reference cam maximum distance	0	214748264 7	214748 2647	LU	U32	IM	T, U
	Description: Sets the maximum distance after the start of the search for reference when traversing to the reference cam.							
	Dependency: Refer to: p2604, p2605, and F07458							
Note: When using a reversing cam, the maximum distance must be set appropriately long.								

Par. No.	Name	Min	Max	Factory Setting	Unit	Data type	Effective	Can be changed
p2608	EPOS search for reference approach velocity zero mark	1	40000000	300	100 0 L U/mi n	U32	IM	T, U
	Description: Sets the approach velocity after detecting the reference cam to search for the zero mark for the search for reference.							
	Dependency: If there is no reference cam, the search for reference immediately starts with the axis traversing to the zero mark. Refer to: p2604, p2609							
	Caution: If the reference cam is not adjusted so that at each search for reference the same zero mark for synchronization is detected, then an "incorrect" axis reference point is obtained. After the reference cam has been left, the search for the zero mark is activated with a time delay due to internal factors. This is the reason that the reference cam should be adjusted in this center between two zero marks and the approach velocity should be adapted to the distance between two zero marks.							
	Note: The velocity override is not effective when traversing to the zero mark.							
p2609	EPOS search for reference max. distance ref. cam and zero mark	0	214748264 7	20000	LU	U32	IM	T, U
	Description: Sets the maximum distance after leaving the reference cam when traversing to the zero mark.							
	Dependency: Refer to: p2604, p2608, and F07459							
p2611	EPOS search for reference approach velocity reference point	1	40000000	300	100 0 L U/mi n	U32	IM	T, U
	Description: Sets the approach velocity after detecting the zero mark to approach the reference point.							
	Dependency: Refer to: p2604, p2609							
	Note: When traversing to the reference point, the velocity override is not effective.							
p2617[0... 15]	EPOS traversing block position	-2147482648	214748264 7	0	LU	I32	IM	T, U
	Description: Sets the target position for the traversing block.							
	Dependency: Refer to: p2618, p2619, p2620, p2621, p2622, p2623							
	Note: The target position is approached in either relative or absolute terms depending on p2623.							
p2618[0... 15]	EPOS traversing block velocity	1	40000000	600	100 0 L U/mi n	I32	IM	T, U
	Description: Sets the velocity for the traversing block.							
	Dependency: Refer to: p2617, p2619, p2620, p2621, p2622, p2623							
	Note: The velocity can be influenced using the velocity override.							
p2619[0... 15]	EPOS traversing block acceleration override	1.0	100.0	100.0	%	Float	IM	T, U
	Description: Sets the acceleration override for the traversing block. The override refers to the maximum acceleration (p2572).							
	Dependency: Refer to: p2572, p2617, p2618, p2620, p2621, p2622, p2623							
p2620[0... 15]	EPOS traversing deceleration override	1.0	100.0	100.0	%	Float	IM	T, U
	Description: Sets the deceleration override for the traversing block. The override refers to the maximum deceleration (p2573).							
	Dependency: Refer to: p2573, p2617, p2618, p2619, p2621, p2622, p2623							

Par. No.	Name	Min	Max	Factory Setting	Unit	Data type	Effective	Can be changed
p2621[0...15]	EPOS traversing block task	1	9	1	%	-	IM	T, U
	Description: Sets the required task for the traversing block. <ul style="list-style-type: none"> • 1: POSITIONING • 2: FIXED STOP • 3: ENDLESS_POS • 4: ENDLESS_NEG • 5: WAIT • 6: GOTO • 7: SET_O • 8: RESET_O • 9: JERK 							
	Dependency: Refer to: p2617, p2618, p2619, p2620, p2622, p2623							
p2622[0...15]	EPOS traversing block task parameter	-2147483648	2147483647	0	-	I32	IM	T, U
	Description: Sets additional information/data of the appropriate task for the traversing block.							
	Dependency: Refer to: p2617, p2618, p2619, p2620, p2621, p2623							
	Note: The following should be set depending on the task: FIXED STOP: Clamping torque and clamping force (rotary 0...65536 [0.01 Nm], linear 0...65536 [N]) WAIT: Delay time [ms] GOTO: Block number SET_O: 1, 2 or 3 - set direct output 1, 2 or 3 (both) RESET_O: 1, 2 or 3 - reset direct output 1, 2 or 3 (both) JERK: 0 - deactivate, 1 - activate							
p2623[0...15]	EPOS traversing block task mode	0	65535	0	-	U16	IM	T, U
	Description: Sets the influence of the task for the traversing block. Value = 0000 cccc bbbb aaaa cccc: Positioning mode cccc = 0000: ABSOLUTE cccc = 0001: RELATIVE cccc = 0010: ABS_POS (only for a rotary axis with modulo correction) cccc = 0011: ABS_NEG (only for a rotary axis with modulo correction) bbbb: Progression condition bbbb = 0000: END bbbb = 0001: CONTINUE WITH STOP bbbb = 0010: CONTINUE FLYING bbbb = 0011: CONTINUE EXTERNAL bbbb = 0100: CONTINUE EXTERNAL WAIT bbbb = 0101: CONTINUE EXTERNAL ALARM aaaa: IDs aaaa = 000x: show/hide block (x = 0: show; x = 1: hide)							
	Dependency: Refer to: p2617, p2618, p2619, p2620, p2621, p2622							
p2634	EPOS fixed stop maximum following error	0	2147482647	1000	LU	U32	IM	T, U
	Description: Sets the following error to detect the "fixed stop reached" state.							
	Dependency: Refer to: p2621							
Note: The state "fixed stop reached" is detected if the following error exceeds the theoretically calculated following error value by p2634.								

Par. No.	Name	Min	Max	Factory Setting	Unit	Data type	Effective	Can be changed
p2635	EPOS fixed stop monitoring window	0	2147482647	100	LU	U32	IM	T, U
	Description: Sets the monitoring window of the actual position after the fixed stop is reached.							
	Dependency: Refer to: F07484							
	Note: If, after the fixed stop is reached, the end stop shifts in either the positive or negative direction by more than the value set here, an appropriate message is output.							
p2690	MDI position fixed setpoint	-2147482648	2147482647	0	-	I32	IM	T, U
	Description: Sets a fixed setpoint for the position.							
p2691	MDI velocity fixed setpoint	1	40000000	600	100 0 L U/mi n	U32	IM	T, U
	Description: Sets a fixed setpoint for the speed.							
p2692	MDI acceleration override, fixed setpoint	0.100	100.000	100.000	%	Float	IM	T, U
	Description: Sets a fixed setpoint for the acceleration override.							
	Dependency: Refer to: p2572							
	Note: The percentage value refers to the maximum acceleration (p2572).							
p2693	MDI deceleration override, fixed setpoint	0.100	100.000	100.000	%	Float	IM	T, U
	Description: Sets a fixed setpoint for the deceleration override.							
	Dependency: Refer to: p2572							
	Note: The percentage value refers to the maximum deceleration (p2573).							
p8920[0...239]	PROFIdrive: Name of station	-	-	-	-	U8	IM	T, U
	Description: Sets the station name for the onboard PROFINET interface on the Control Unit. The active station name is displayed in r8930.							
	Note: The interface configuration (p8920 and following) is activated with p8925. The parameter is not influenced by setting the factory setting.							
p8921[0...3]	PROFIdrive: IP address of station	0	255	0	-	U8	IM	T, U
	Description: Sets the IP address for the onboard PROFINET interface on the Control Unit. The active IP address is displayed in r8931.							
	Note: The interface configuration (p8920 and following) is activated with p8925. The parameter is not influenced by setting the factory setting.							
p8922[0...3]	PROFIdrive: Default gateway of station	0	255	0	-	U8	IM	T, U
	Description: Sets the default gateway for the onboard PROFINET interface on the Control Unit. The active default gateway is displayed in r8932.							
	Note: The interface configuration (p8920 and following) is activated with p8925. The parameter is not influenced by setting the factory setting.							
p8923[0...3]	PROFIdrive: Subnet mask of station	0	255	0	-	U8	IM	T, U
	Description: Sets the subnet mask for the onboard PROFINET interface on the Control Unit. The active subnet mask is displayed in r8933.							
	Note: The interface configuration (p8920 and following) is activated with p8925. The parameter is not influenced by setting the factory setting.							

Par. No.	Name	Min	Max	Factory Setting	Unit	Data type	Effective	Can be changed
p8925	PROFIdrive: Interface configuration	0	3	0	-	U8	IM	T, U
	<p>Description: Setting to activate the interface configuration for the onboard PROFINET interface on the Control Unit.</p> <p>p8925 is automatically set to 0 at the end of the operation.</p> <ul style="list-style-type: none"> • p8925 = 0: No function • p8925 = 2: Save and activate configuration <p>The interface configuration (p8920 and following) is saved and activated after the next POWER ON.</p>							
p29000 *	Motor ID	0	65535	0	-	U16	IM	T
	<p>Description: Motor type number is printed on the motor rating plate as motor ID.</p> <p>For a motor with an incremental encoder, users need to manually input the parameter value.</p> <p>For a motor with an absolute encoder, the drive automatically reads the parameter value.</p>							
p29001	Reversal of motor direction	0	1	0	-	I16	IM	T
	<p>Description: Reversal of motor running direction. By default, CW is the positive direction while CCW the negative direction. After changing of p29001, reference point will lost, A7461 will remind user to referencing again.</p> <ul style="list-style-type: none"> • 0: No reversal • 1: Reverse 							
p29002	BOP display selection	0	4	0	-	I16	IM	T, U
	<p>Description: Selection of BOP operating display.</p> <ul style="list-style-type: none"> • 0: Actual speed (default) • 1: DC voltage • 2: Actual torque • 3: Actual position • 4: Position following error 							
p29003	Control mode	1	2	2	-	I16	IM	T
	<p>Description: Selection of control mode.</p> <ul style="list-style-type: none"> • 1: Basic positioner control mode (EPOS) • 2: Speed control mode (S) 							
p29005	Braking resistor capacity percentage alarm threshold	1	100	100	%	Float	IM	T
	<p>Description: Alarm triggering threshold for the capacity of the internal braking resistor.</p> <p>Alarm number: A52901</p>							
p29006	Line supply voltage	200	480	400/230	V	U16	IM	T
	<p>Description: Nominal Line supply voltage, effective value of line to line voltage. Drive can operate within -15% to +10% error.</p> <p>For 400 V variant servo drive, the value range is 380 V to 480 V, default value is 400 V.</p> <p>For 200 V variant servo drive, the value range is 200 V to 240 V, default value is 230 V.</p>							
p29020[0..1]	Tuning: Dynamic factor	1	35	18	-	U16	IM	T, U
	<p>Description: The dynamic factor of auto tuning. 35 dynamic factors in total are available.</p> <p>Index:</p> <ul style="list-style-type: none"> • [0]: Dynamic factor for one-button auto tuning • [1]: Dynamic factor for real-time auto tuning 							

Par. No.	Name	Min	Max	Factory Setting	Unit	Data type	Effective	Can be changed
p29021	Tuning: Mode selection	0	5	0	-	I16	IM	T
	Description: Selection of a tuning mode. <ul style="list-style-type: none"> • 0: Disabled • 1: One-button auto tuning • 3: Real-time auto tuning • 5: Disable with default controller parameters 							
p29022	Tuning: Ratio of total inertia moment to motor inertia moment	1.00	10000.00	1.00	-	Float	IM	T, U
	Description: Ratio of total inertia moment to servo motor inertia moment.							
p29023	Tuning: One-button auto tuning configuration	-	-	0x0007	-	U16	IM	T
	Description: One-button auto tuning configuration. <ul style="list-style-type: none"> • Bit 0: The speed controller gain is determined and set using a noise signal. • Bit 1: Possible required current setpoint filters are determined and set using a noise signal. As a consequence, a higher dynamic performance can be achieved in the speed control loop. • Bit 2: The inertia moment ratio (p29022) can be measured after this function is running. If not set, the inertia moment ratio must be set manually with p29022. • Bit 7: With this bit set, multi-axes are adapted to the dynamic response set in p29028. This is necessary for interpolating axes. The time in p29028 should be set according to the axis with the lowest dynamic response. 							
p29024	Tuning: Real-time auto tuning configuration	-	-	0x004c	-	U16	IM	T
	Description: Real-time auto tuning configuration. <ul style="list-style-type: none"> • Bit 2: The inertia moment ratio (p29022) is estimated while the motor is running, if not set, the inertia moment ratio must be set manually with p29022. • Bit 3: If not set, the inertia moment ratio (p29022) is estimated only once and the inertia estimator is deactivated automatically after the estimation is completed. If the bit is set to 1, the inertia moment ratio is estimated in real time and the controller adapts the parameters continuously. You are recommended to save the parameters when the estimation result is satisfied. After that, when you power on the drive next time, the controller will be started with the optimized parameters. • Bit 6: The adaption of current setpoint filter. This adaption may be necessary if a mechanical resonance frequency changes in operation. It can also be used to dampen a fixed resonance frequency. Once the control loop has stabilized, this bit should be deactivated and to save parameters in a non-volatile memory. • Bit 7: With this bit set, multi-axes are adapted to the dynamic response set in p29028. This is necessary for interpolating axes. The time in p29028 should be set according to the axis with the lowest dynamic response. 							
p29025	Tuning: Configuration overall	-	-	0x0004	-	U16	IM	T
	Description: Overall configuration of auto tuning, apply for both one-button and real-time auto tuning. <ul style="list-style-type: none"> • Bit 0: For significant differences between the motor and load moment of inertia, or for low dynamic performance of the controller, then the P controller becomes a PD controller in the position control loop. As a consequence, the dynamic performance of the position controller is increased. This function should only be set when the speed pre-control (bit 3 = 1) or the torque pre-control (bit 4 = 1) is active. • Bit 1: At low speeds, the controller gain factors are automatically reduced in order to avoid noise and oscillation at standstill. This setting is recommended for incremental encoders. • Bit 2: The estimated load moment of inertia is taken into account for the speed controller gain. • Bit 3: Activates the speed pre-control for the position controller. • Bit 4: Activates the torque pre-control for the position controller. • Bit 5: Adapts acceleration limit. 							

Par. No.	Name	Min	Max	Factory Setting	Unit	Data type	Effective	Can be changed
p29026	Tuning: Test signal duration	0	5000	2000	ms	U32	IM	T
	Description: The duration time of the one-button auto tuning test signal.							
p29027	Tuning: Limit rotation of motor	0	30000	0	°	U32	IM	T
	Description: The limit position with motor rotations during one-button auto tuning. The traversing range is limited within +/- p29027 degrees (motor run one revolution is 360 degree).							
p29028	Tuning: Pre-control time constant	0.0	60.0	7.5	ms	Float	IM	T, U
	<p>Description: Sets the time constant for the pre-control symmetrization for auto tuning. As a consequence, the drive is allocated a defined, dynamic response via its pre-control. For drives, which must interpolate with one another, the same value must be entered. The higher this time constant is, the smoother the drive will follow the position set point.</p> <p>Note: This time constant is only effective when multi-axis interpolation is selected (bit 7 of p29023 and p29024).</p>							
p29035	VIBSUP activation	0	1	0	-	I16	IM	T
	<p>Description: Select the VIBSUP ON/OFF.</p> <p>Position setpoint filter can be activated (p29035) for EPOS control mode.</p> <ul style="list-style-type: none"> 0: Disable Filter is not activated. 1: Enable Filter is activated. 							
p29050[0..1]	Torque limit upper	-150	300	300	%	Float	IM	T, U
	<p>Description: Positive torque limit.</p> <p>Two internal torque limits in total are available. You can select the internal parameters as the source of the torque limit with the digital input signals TLIM.</p>							
p29051[0..1]	Torque limit lower	-300	150	-300	%	Float	IM	T, U
	<p>Description: Negative torque limit.</p> <p>Two internal torque limits in total are available. You can select the internal parameters as the source of the torque limit with the digital input signals TLIM.</p>							
p29070[0..1] *	Speed limit positive	0	210000	210000	rpm	Float	IM	T, U
	<p>Description: Positive speed limit.</p> <p>Two internal speed limits in total are available. You can select the internal parameters as the source of the speed limit with the digital input signals SLIM.</p>							
p29071[0..1] *	Speed limit negative	-210000	0	-210000	rpm	Float	IM	T, U
	<p>Description: Negative speed limit.</p> <p>Two internal speed limits in total are available. You can select the internal parameters as the source of the speed limit with the digital input signals SLIM.</p>							
p29080	Overload threshold for output signal triggering	10	300	100	%	Float	IM	T
	Description: Overload threshold for the output power.							

Par. No.	Name	Min	Max	Factory Setting	Unit	Data type	Effective	Can be changed
p29108	Function module activate	0	0xffffffff	0	-	U32	RE	T
	Description: Bit 0: activate extended setpoint channel including ramp-function generator (RFG), speed limit (SLIM), and JOG. <ul style="list-style-type: none"> • Bit 0 = 0: Deactivate • Bit 0 = 1: Activate 							
	Note: Changes only become effective after save and repower-on. Currently, you can set bit 0 only.							
p29110 **	Position loop gain	0.000	300.000	1.800	100 0/min	Float	IM	T, U
	Description: Position loop gain. Two position loop gains in total are available. You can switch between these two gains by configuring the digital input signal G-CHANGE or setting relevant condition parameters. The first position loop gain is the default setting.							
	Dependency: The parameter value will be set to default after configuring a new motor ID (p29000).							
p29111	Speed pre-control factor (feed forward)	0.00	200.00	0.00	%	Float	IM	T, U
	Description: Setting to activate and weight the speed pre-control value. Value = 0%: The pre-control is deactivated.							
p29120**	Speed loop gain	0.00	999999.00	Motor dependent	Nms/rad	Float	IM	T, U
	Description: Speed loop gain.							
	Dependency: The parameter value will be set to default after configuring a new motor ID (p29000).							
p29121*	Speed loop integral time	0.00	100000.00	15	ms	Float	IM	T, U
	Description: Speed loop integral time.							
	Dependency: The parameter value will be set to default after configuring a new motor ID (p29000).							
p29150	User defined PZD receive	0	2	0	-	I16	IM	T
	Description: Select the function of control PZD12 when using telegram 111. <ul style="list-style-type: none"> • 0: No function • 1: Additional torque setpoint • 2: Additional speed setpoint 							
p29151	User defined PZD send	0	3	0	-	I16	IM	T
	Description: Select the function of status PZD12 when using telegram 111. <ul style="list-style-type: none"> • 0: No function • 1: Actual torque • 2: Actual absolute current • 3: DI status 							
p29230	MDI direction selection	0	2	0	-	I16	IM	T
	Description: MDI direction selection: <ul style="list-style-type: none"> • 0: Absolute positioning through the shortest distance • 1: Absolute positioning in the positive direction • 2: Absolute positioning in the negative direction 							
	Dependency: This parameter is only valid for modulo axis (p29245 = 1).							
p29231	MDI positioning type	0	1	0	-	I16	IM	T
	Description: MDI positioning type: <ul style="list-style-type: none"> • 0: Relative positioning • 1: Absolute positioning 							

Par. No.	Name	Min	Max	Factory Setting	Unit	Data type	Effective	Can be changed
p29240	Select referencing mode	0	2	1	-	I16	IM	T
	Description: Selects referencing mode. <ul style="list-style-type: none"> • 0: Referencing with external signal REF • 1: Referencing with external reference cam (signal REF) and encoder zero mark • 2: Referencing with zero mark only 							
p29243	Positioning tracking activate	0	1	0	-	I16	IM	T
	Description: Activation of position tracking. <ul style="list-style-type: none"> • 0: Deactivated • 1: Activated 							
p29244	Absolute encoder virtual rotary revolutions	0	4096	0	-	U32	IM	T
	Description: Sets the number of rotations that can be resolved for an encoder with activated position tracking function (p29243 = 1).							
p29245	Axis mode state	0	1	0	-	U32	IM	T
	Description: Linear/modulo mode: <ul style="list-style-type: none"> • 0: Linear axis • 1: Modulo axis 							
p29246 *	Modulo correction range	1	214748264 7	360000	-	U32	IM	T
	Description: Modulo number, effective on modulo mode (P29245=1)							
p29247 *	Mechanical gear: LU per revolution	1	214748364 7	10000	-	U32	IM	T
	Description: LU per load revolution.							
p29248 *	Mechanical gear: Numerator	1	1048576	1	-	U32	IM	T
	Description: (Load/Motor) Load revolutions.							
p29249 *	Mechanical gear: Denominator	1	1048576	1	-	U32	IM	T
	Description: (Load/Motor) Motor revolutions.							
p29301	Digital input 1 assignment	0	29	2	-	I16	IM	T
	Description: Defines the function of digital input signal DI1 <ul style="list-style-type: none"> • 0: NA • 2: RESET • 3: CWL • 4: CCWL • 11: TLIM • 20: SLIM • 24: REF • 29: EMGS 							
p29302	Digital input 2 assignment	0	29	11	-	I16	IM	T
	Description: Defines the function of digital input signal DI2							
p29303	Digital input 3 assignment	0	29	0	-	I16	IM	T
	Description: Defines the function of digital input signal DI3							
p29304	Digital input 4 assignment	0	29	0	-	I16	IM	T
	Description: Defines the function of digital input signal DI4							

Par. No.	Name	Min	Max	Factory Setting	Unit	Data type	Effective	Can be changed
p29330	Digital output 1 assignment	1	15	2	-	I16	IM	T
	Description: Defines the function of digital output signal DO1 <ul style="list-style-type: none"> • 1: RDY • 2: FAULT • 3: INP • 4: ZSP • 6: TLR • 8: MBR • 9: OLL • 12: REFOK • 14: RDY_ON • 15: STO_EP 							
p29331	Digital output 2 assignment	1	15	9	-	I16	IM	T
	Description: Defines the function of digital output signal DO2							
p29360	Brake resistor alarm active	0	1	1	-	I16	IM	T, U
	Description: Configure the deactivation of the brake resistor alarm. <ul style="list-style-type: none"> • 0: A52901 monitor is activated. • 1: A52901 monitor is deactivated. 							
p29418	Fine resolution G1_XIST1 (in bits)	2	18	11	-	U8	IM	T
	Description: Sets the fine resolution in bits of the incremental position actual values G1_XIST1.							
	Note: The fine resolution specifies the fraction between two encoder pluses. The number of pulses for one encoder revolution is 2048, so the effective resolution is 2048×2^{p29418} . The default value is automatically adjusted with the encoder type.							
p29419	Fine resolution G1_XIST2 (in bits)	2	18	9	-	U8	IM	T
	Description: Sets the fine resolution in bits of the absolute position actual values G1_XIST2.							
	Note: The fine resolution specifies the fraction between two encoder pluses. The number of pulses for one encoder revolution is 2048, so the effective resolution is 2048×2^{p29419} . The default value is automatically adjusted with the encoder type.							
p31581	VIBSUP filter type	0	1	0	-	I16	IM	T
	Description: Sets the filter type for VIBSUP. Depending on the selected filter type, the VIBSUP filter results in motion sequences that take somewhat longer. <ul style="list-style-type: none"> • 0: The rugged VIBSUP filter has a lower sensitivity to frequency offsets compared with the sensitive filter type, but results in a higher delay of the motion sequence. The total motion sequence is extended by the time period T_d ($T_d = 1/f_d$). • 1: The sensitive VIBSUP filter has a higher sensitivity to frequency offsets compared with the rugged filter type, but results in a lower delay of the motion sequence. The total motion sequence is extended by half the time period $T_d/2$ ($T_d = 1/f_d$). 							
p31585	VIBSUP filter frequency	0.5	62.5	1	Hz	Float	IM	T
	Description: Sets the frequency of the damped natural vibration of the mechanical system. This frequency can be determined by making the appropriate measurements.							
Note: The maximum frequency that can be set depends on the filter sampling time.								
p31586	VIBSUP filter damping	0	0.99	0.03	-	Float	IM	T
	Description: Sets the value for the damping of the natural mechanical vibration to be filtered. Typically, the damping value is about 0.03, and can be optimized by performing the appropriate positioning tests.							

Read-only parameters

Par. No.	Name	Unit	Data type
r0020	Speed setpoint smoothed	rpm	Float
	Description: Displays the currently smoothed speed setpoint at the input of the speed controller or U/f characteristic (after the interpolator).		
	Note: Smoothing time constant = 100 ms The signal is not suitable as a process quantity and may only be used as a display quantity. The speed setpoint is available smoothed (r0020) and unsmoothed.		
r0021	Actual speed smoothed	rpm	Float
	Description: Displays the smoothed actual value of the motor speed.		
	Note: Smoothing time constant = 100 ms The signal is not suitable as a process quantity and may only be used as a display quantity. The speed actual value is available smoothed (r0021) and unsmoothed.		
r0026	DC link voltage smoothed	V	Float
	Description: Displays the smoothed actual value of the DC link voltage.		
	Note: Smoothing time constant = 100 ms The signal is not suitable as a process quantity and may only be used as a display quantity. The DC link voltage is available smoothed.		
r0027	Absolute actual current smoothed	Arms	Float
	Description: Displays the smoothed absolute actual current value.		
	Notice: This smoothed signal is not suitable for diagnostics or evaluation of dynamic operations. In this case, the unsmoothed value should be used.		
	Note: Smoothing time constant = 100 ms The signal is not suitable as a process quantity and may only be used as a display quantity. The absolute current actual value is available smoothed (r0027) and unsmoothed.		
r0029	Current actual value field-generating smoothed	Arms	Float
	Description: Displays the smoothed field-generating actual current.		
	Note: Smoothing time constant = 100 ms The signal is not suitable as a process quantity and may only be used as a display quantity. The field-generating current actual value is available smoothed (r0029) and unsmoothed.		
r0030	Current actual value torque-generating smoothed	Arms	Float
	Description: Displays the smoothed torque-generating actual current.		
	Note: Smoothing time constant = 100 ms The signal is not suitable as a process quantity and may only be used as a display quantity. The torque-generating current actual value is available smoothed.		
r0031	Actual torque smoothed	Nm	Float
	Description: Displays the smoothed torque actual value.		
	Note: Smoothing time constant = 100 ms The signal is not suitable as a process quantity and may only be used as a display quantity. The torque actual value is available smoothed (r0031) and unsmoothed.		
r0034	Motor utilization thermal	%	Float
	Description: Displays the motor utilization from motor temperature model 1 (I ² t) or 3.		

Par. No.	Name	Unit	Data type
r0037[0...19]	Power unit temperatures	°C	Float
	Description: Displays the temperatures in the power unit.		
	Index:		
	<ul style="list-style-type: none"> • [0]: Inverter maximum value • [1]: Depletion layer maximum value • [2]: Rectifier maximum value • [3]: Air intake • [4]: Interior of power unit • [5]: Inverter 1 • [6]: Inverter 2 • [7]: Inverter 3 • [8]: Inverter 4 • [9]: Inverter 5 • [10]: Inverter 6 • [11]: Rectifier 1 • [12]: Rectifier 2 • [13]: Depletion layer 1 • [14]: Depletion layer 2 • [15]: Depletion layer 3 • [16]: Depletion layer 4 • [17]: Depletion layer 5 • [18]: Depletion layer 6 • [19]: Cooling unit liquid intake 		
	Dependency: Refer to A01009		
	Notice: Only for internal Siemens troubleshooting. Note: The value of -200 indicates that there is no measuring signal. <ul style="list-style-type: none"> • r0037[0]: Maximum value of the inverter temperatures (r0037[5...10]). • r0037[1]: Maximum value of the depletion layer temperatures (r0037[13...18]). • r0037[2]: Maximum value of the rectifier temperatures (r0037[11...12]). The maximum value is the temperature of the hottest inverter, depletion layer, or rectifier.		
r0079[0...1]	Torque setpoint total	Nm	Float
	Description: Displays and connector output for the torque setpoint at the output of the speed controller (before clock cycle interpolation).		
	Index: <ul style="list-style-type: none"> • [0]: Unsmoothed • [1]: Smoothed 		
r0296	DC link voltage undervoltage threshold	V	U16
	Description: Threshold to detect a DC link undervoltage. If the DC link voltage falls below this threshold, the drive unit is tripped due to a DC link undervoltage condition.		
	Note: The value depends on the device type and the selected device rated voltage.		
r0297	DC link voltage overvoltage threshold	V	U16
	Description: If the DC link voltage exceeds the threshold specified here, the drive unit is tripped due to DC link overvoltage.		
	Dependency: Refer to F30002.		
r0311	Rated motor speed	rpm	Float
	Description: Displays the rated motor speed (rating plate).		

Par. No.	Name	Unit	Data type
r0333	Rated motor torque	Nm	Float
	Description: Displays the rated motor torque. IEC drive: unit Nm NEMA drive: unit lbf ft		
r0482[0...2]	Encoder actual position value Gn_XIST1	-	U32
	Description: Displays the encoder actual position value Gn_XIST1 .		
	Index: <ul style="list-style-type: none"> • [0]: Encoder 1 • [1]: Encoder 2 • [2]: Reserved Note: <ul style="list-style-type: none"> • In this value, the measuring gear is only taken into account when the position tracking is activated. • The update time for the position control (EPOS) corresponds to the position controller clock cycle. • The update time in isochronous operation corresponds to the bus cycle time. • The update time in isochronous operation and with position control (EPOS) corresponds to the position controller clock cycle. • The update time in non-isochronous operation or without position control (EPOS) comprises the following: <ul style="list-style-type: none"> – Update time = 4 * least common multiple (LCM) of all current controller clock cycles in the drive group (infeed + drives). The minimum update time is 1 ms. – Example 1: infeed, servo Update time = 4 * LCM(250 µs, 125 µs) = 4 * 250 µs = 1 ms – Example 2: infeed, servo, vector Update time = 4 * LCM(250 µs, 125 µs, 500 µs) = 4 * 500 µs = 2 ms 		
r0632	Motor temperature model, stator winding temperature	°C	Float
	Description: Displays the stator winding temperature of the motor temperature model.		
r0722	CU digital inputs status	-	U32
	Description: Displays the status of the digital inputs. Note: DI: Digital Input DI/DO: Bidirectional Digital Input/Output The drive unit displays the value in hex format. You can convert the hex number to the binary number, for example, FF (hex) = 11111111 (bin).		
r0747	CU digital outputs status	-	U32
	Description: Displays the status of digital outputs. Note: DI/DO: Bidirectional Digital Input/Output The drive unit displays the value in hex format. You can convert the hex number to the binary number, for example, FF (hex) = 11111111 (bin).		
r0930	PROFIdrive operating mode	-	U16
	Description: Displays the operating mode. <ul style="list-style-type: none"> • 1: Closed-loop speed controlled operation with ramp-function generator • 2: Closed-loop position controlled operation • 3: Closed-loop speed controlled operation without ramp-function generator 		

Par. No.	Name	Unit	Data type
r0945[0...63]	Fault code	-	U16
	Description: Displays the number of faults that have occurred.		
	Dependency: Refer to r0949		
	Note: The buffer parameters are cyclically updated in the background. Fault buffer structure (general principle): r0945[0], r0949[0] → actual fault case, fault 1 ... r0945[7], r0949[7] → actual fault case, fault 8 r0945[8], r0949[8] → 1st acknowledged fault case, fault 1 ... r0945[15], r0949[15] → 1st acknowledged fault case, fault 8 ... r0945[56], r0949[56] → 7th acknowledged fault case, fault 1 ... r0945[63], r0949[63] → 7th acknowledged fault case, fault 8		
r0949[0...63]	Fault value	-	I32
	Description: Displays additional information about the fault that occurred (as integer number).		
	Dependency: Refer to r0945		
	Note: The buffer parameters are cyclically updated in the background. The structure of the fault buffer and the assignment of the indices is shown in r0945.		
r0964[0...6]	Device identification	-	U16
	Description: Displays the device identification.		
	Index: <ul style="list-style-type: none"> • [0]: Company (Siemens = 42) • [1]: Device type • [2]: Firmware version • [3]: Firmware data (year) • [4]: Firmware data (day/month) • [5]: Number of drive objects • [6]: Firmware patch/hot fix 		
	Note: Example: r0964[0] = 42 → SIEMENS r0964[1] = Device type r0964[2] = 403 → First part of the firmware version V04.03 (for second part, refer to index 6) r0964[3] = 2010 → Year 2010 r0964[4] = 1705 → 17th of May r0964[5] = 2 → 2 drive objects r0964[6] = 200 → Secnod part, firmware version (complete version: V04.03.02.00)		
r0965	PROFdrive profile number	-	U16
	Description: Displays the PROFdrive profile and profile version.		
	Constant value = 0329 hex Byte 1: Profile number = 03 hex = PROFdrive profile Byte 2: Profile version = 29 hex = Version 4.1		
	Note: When the parameter is read via PROFdrive, the Octet String 2 data type applies.		

Par. No.	Name	Unit	Data type
r0975[0...10]	Drive object identification	-	U16
	Description: Displays the identification of the drive object.		
	Index: <ul style="list-style-type: none"> • [0]: Company (Siemens = 42) • [1]: Drive object type • [2]: Firmware version • [3]: Firmware data (year) • [4]: Firmware data (day/month) • [5]: PROFIdrive drive object type class • [6]: PROFIdrive drive object sub-type class 1 • [7]: Drive object number • [8]: Reserved • [9]: Reserved • [10]: Firmware patch/hot fix 		
	Note: Example: r0975[0] = 42 → SIEMENS r0975[1] = SERVO drive object type r0975[2] = 102 → First part of the firmware version V01.02 (for second part, refer to index 10) r0975[3] = 2003 → Year 2003 r0975[4] = 1401 → 14th of January r0975[5] = 1 → PROFIdrive drive object, type class r0975[6] = 9 → PROFIdrive drive object sub-type class 1 r0975[7] = 2 → Drive object number = 2 r0975[8] = 0 (Reserved) r0975[9] = 0 (Reserved) r0975[10] = 600 → Sencod part, firmware version (complete version: V01.02.06.00)		
r0979[0...30]	PROFIdrive encoder format	-	U32
	Description: Displays the actual position encoder used according to PROFIdrive.		
	Index: <ul style="list-style-type: none"> • [0]: Header • [1]: Type encoder 1 • [2]: Resolution encoder 1 • [3]: Shift factor G1_XIST1 • [4]: Shift factor G1_XIST2 • [5]: Distinguishable revolutions encoder 1 • [6]...[30]: Reserved 		
	Note: Information about the individual indices can be taken from the following literature: PROFIdrive Profile Drive Technology		
r2043.0...2	PROFIdrive: PZD state	-	U8
	Description: Displays the PROFIdrive PZD state.		
	Bit 0: Setpoint failure <ul style="list-style-type: none"> • Value = 1: Yes • Vaule = 0: No Bit 1: Clock cycle synchronous operation active <ul style="list-style-type: none"> • Vaule = 1: Yes • Vaule = 0: No Bit 2: Fieldbus operation <ul style="list-style-type: none"> • Value = 1: Yes • Vaule = 0: No 		
	Note: When using the "setpoint failure" signal, the bus can be monitored and an application-specific response triggered when the setpoint fails.		

Par. No.	Name	Unit	Data type
r2050[0...19]	PROFIdrive: PZD receive word	-	I16
	Description: Displays the PZD (setpoints) with word format received from the fieldbus controller.		
	Dependency: Refer to r2060.		
	Index: Index 0 to index 19 stand for PZD1 to PZD20 correspondingly.		
r2053[0...27]	PROFIdrive: Diagnostics PZD send word	-	U16
	Description: Displays the PZD (actual values) with word format send to the fieldbus controller.		
	Index: Index 0 to index 27 stand for PZD1 to PZD28 correspondingly.		
	Bit field: For each PZD, it has 16 bits from bit 0 to bit 15. For the control words, if the bit value equals to 0, the function of the bit is OFF; if the bit vaule equals to 1, the function of the bit is ON.		
r2060[0...18]	PROFIdrive: PZD receive double word	-	I32
	Description: Displays the PZD (setpoints) with double word format received from the fieldbus controller.		
	Dependency: Refer to r2050.		
	Index: Index [n] = PZD[n + 1] + n + 2 In the formula, n = 0...18.		
Notice: A maximum of 4 indices of the "trace" function can be used.			
r2063[0...26]	PROFIdrive: Diagnostics PZD send double word	-	U32
	Description: Displays the PZD (actual values) with double word format send to the fieldbus controller.		
	Index: Index [n] = PZD[n + 1] + n + 2 In the formula, n = 0...26.		
	Bit field: For each PZD, it has 32 bits from bit 0 to bit 31. For the control words, if the bit value equals to 0, the function of the bit is OFF; if the bit vaule equals to 1, the function of the bit is ON.		
Notice: A maximum of 4 indices of the "trace" function can be used.			
r2090.0...15	PROFIdrive: PZD1 receive bit-serial	-	U16
	Description: Bit-serial description of PZD1 (normally control word 1) received from the PROFIdrive controller. If the value of the bit equals to 0, it means the function of this bit is deactivated. If the value of the bit equals to 1, it means the function of this bit is activated.		
r2091	PROFIdrive: PZD2 receive bit-serial	-	U16
	Description: Binector output for bit-serial interconnection of PZD2 received from the PROFIdrive controller.		
r2092	PROFIdrive: PZD3 receive bit-serial	-	U16
	Description: Binector output for bit-serial interconnection of PZD3 received from the PROFIdrive controller.		
r2093.0...15	PROFIdrive: PZD4 receive bit-serial	-	U16
	Description: Bit-serial description of PZD4 (normally control word 2) received from the PROFIdrive controller. If the value of the bit equals to 0, it means the function of this bit is deactivated. If the value of the bit equals to 1, it means the function of this bit is activated.		
r2094	PROFIdrive: MDI_MOD receive bit-serial for telegram 9	-	U16
	Description: Binector output for bit-serial onward interconnection of a PZD word received from the PROFIdrive controller.		

Par. No.	Name	Unit	Data type
r2122[0...63]	Alarm code	-	U16
	Description: Displays the number of faults that have occurred.		
	Dependency: Refer to r2124		
	Note: The buffer parameters are cyclically updated in the background. Alarm buffer structure (general principle): r2122[0], r2124[0] → alarm 1 (the oldest) ... r2122[7], r2124[7] → alarm 8 (the latest) When the alarm buffer is full, the alarms that have gone are entered into the alarm history: r2122[8], r2124[8] → alarm 1 (the latest) ... r2122[63], r2124[63] → alarm 1 (the oldest)		
r2124[0...63]	Alarm value	-	I32
	Description: Displays additional information about the active alarm (as integer number).		
	Dependency: Refer to r2122		
	Note: The buffer parameters are cyclically updated in the background. The structure of the alarm buffer and the assignment of the indices is shown in r2122.		
r2521[0...3]	LR position actual value	LU	I32
	Description: Display and connector output for the actual position actual value determined by the position actual value preprocessing. Index: <ul style="list-style-type: none"> • [0]: CI-loop position control • [1]: Encoder 1 • [2]: Encoder 2 • [3]: Reserved 		
r2556	LR position setpoint after setpoint smoothing	LU	I32
Description: Display and connector output for the position setpoint after setpoint smoothing.			
r2563	LR following error dynamic model	LU	I32
	Description: Display and connector output for the dynamic following error. This value is the deviation, corrected by the velocity-dependent component, between the position setpoint and the position actual value.		
r2665	EPOS position setpoint	LU	I32
	Description: Displays the actual absolute position setpoint.		
r8909	PROFIdrive: Device ID	-	U16
	Description: Displays the PROFINET device ID. Every SINAMICS device type has its own PROFINET device ID and its own PROFINET GSD.		
r8930[0...239]	PROFIdrive: Active name of station	-	U8
	Description: Displays the active station name for the onboard PROFINET interface on the Control Unit.		
r8931[0...3]	PROFIdrive: Active IP address of station	-	U8
	Description: Displays the active IP address for the onboard PROFINET interface on the Control Unit.		
r8932[0...3]	PROFIdrive: Active default gateway of station	-	U8
	Description: Displays the active default gateway for the onboard PROFINET interface on the Control Unit.		
r8933[0...3]	PROFIdrive: Active subnet mask of station	-	U8
	Description: Displays the active subnet mask for the onboard PROFINET interface on the Control Unit.		
r8935	PROFIdrive: MAC address of station	-	U8
	Description: Displays the MAC address for the onboard PROFINET interface on the Control Unit.		

Par. No.	Name	Unit	Data type
r8939	PROFIdrive: Device access point (DAP) ID	-	U32
	Description: Displays the PROFINET device access point ID for the onboard PROFINET interface. The combination of device ID (r8909) and DAP ID uniquely identifies a PROFINET access point.		
r29018[0...1]	OA version	-	Float
	Description: Displays the OA version.		
	Index: <ul style="list-style-type: none"> • [0]: Firmware version • [1]: Build increment number 		
r29400	Internal control signal status indicating	-	U32
	Description: Control signal status identifiers The bits of the parameter are reserved except the following ones: <ul style="list-style-type: none"> • Bit 1: RESET • Bit 2: CWL • Bit 3: CCWL • Bit 10: TLIM • Bit 19: SLIM • Bit 23: REF • Bit 28: EMGS 		
r29942	DO signals status indicating	-	U32
	Description: Indicates the status of DO signals. <ul style="list-style-type: none"> • Bit 0: RDY • Bit 1: FAULT • Bit 2: Reserved • Bit 3: ZSP • Bit 4: Reserved • Bit 5: TLR • Bit 6: Reserved • Bit 7: MBR • Bit 8: OLL • Bit 9: Reserved • Bit 10: Reserved • Bit 11: Reserved • Bit 12: Reserved • Bit 13: RDY_ON • Bit 14: STO_EP 		

8 Diagnostics

8.1 Overview

General information about faults and alarms

The errors and states detected by the individual components of the drive system are indicated by messages.

The messages are categorized into faults and alarms.

Properties of faults and alarms

- **Faults**
 - Are identified by Fxxxx.
 - Can lead to a fault reaction.
 - Must be acknowledged once the cause has been remedied.
 - Status via control unit and LED RDY.
 - Status via PROFINET status word ZSW1.3.
 - Entry in the fault buffer.
- **Alarms**
 - Are identified by Axxxx.
 - Have no further effect on the drive.
 - The alarms are automatically reset once the cause has been remedied. No acknowledgement is required.
 - Status via Control Unit and LED RDY.
 - Status via PROFINET status word ZSW1.7.
 - Entry in the alarm buffer.
- **General properties of faults and alarms**
 - Triggering on selected messages possible.
 - Contain the component number for identifying the affected SINAMICS component.
 - Contain diagnostic information on the relevant message.

Differences between faults and alarms

The differences between faults and alarms are shown as follows:

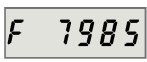
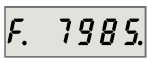
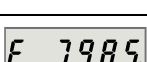
Type	BOP display (example)		Status indicator		Reaction	Acknowledgement
			RDY	COM		
Fault		Single fault	Slow flashing in red	-	<ul style="list-style-type: none"> • NONE: no reaction • OFF1: servo motor ramps down • OFF2: servo motor coasts down • OFF3: servo motor stops quickly (emergency stop) • ENOCDER: Encoder fault causes OFF2. 	<ul style="list-style-type: none"> • POWER ON: re-power on the servo drive to clear a fault after eliminating its cause. • IMMEDIATELY: the fault disappears immediately after eliminating its cause. • PULSE INHIBIT: The fault can only be acknowledged with a pulse inhibit. The same options are available for acknowledging as described under acknowledgment with IMMEDIATELY.
		The first fault in the case of multiple faults				
		Non-first fault in the case of multiple faults				

Type	BOP display (example)		Status indicator		Reaction	Acknowledgement
			RDY	COM		
Alarm		Single alarm	Slow flashing in red	-	• NONE : no reaction	Self-acknowledgement
		The first alarm in the case of multiple alarms				
		Non-first alarm in the case of multiple alarms				

NOTICE

Faults are displayed in prior to alarms

If both faults and alarms occur, faults are displayed in prior to alarms. Alarms are displayed only after all faults have been acknowledged.

BOP operations for faults and alarms

To view faults or alarms, proceed as follows:

- Faults



- Alarms

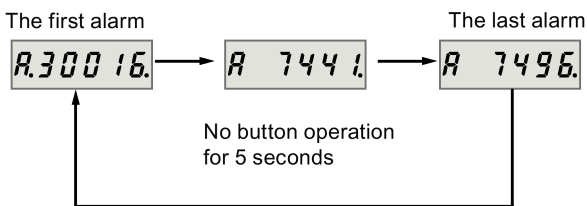

To exit from fault or alarm display, proceed as follows:

- Faults

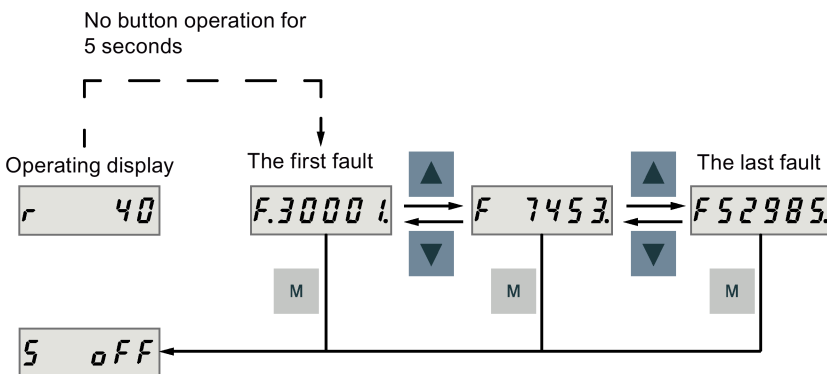

- Alarms

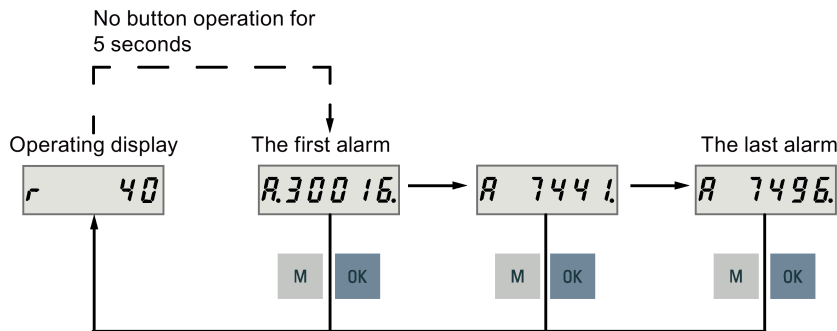

To acknowledge faults, proceed as follows:

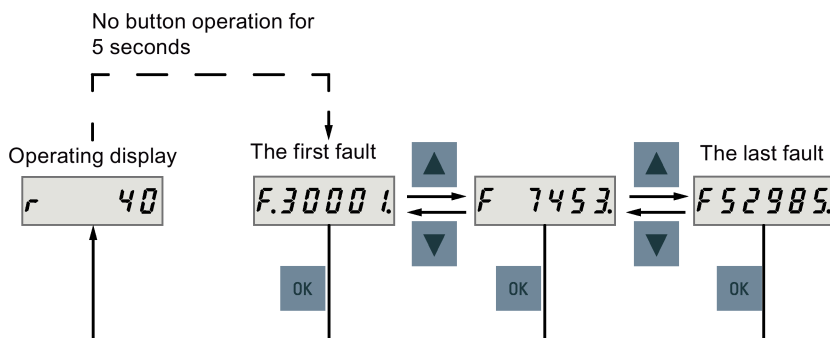

Note

- If you do not eliminate the cause(s) of the fault, it can appear again after no button operation for five seconds. Make sure that you have eliminated the cause(s) of the fault.
- You can acknowledge faults using RESET signal. For details of the signal, refer to SINAMICS V90, SIMOTICS S-1FL6 Operating Instructions.

8.2 List of faults and alarms

This section lists only common faults and alarms. To view the detailed information of all faults and alarms, call the online help for an active fault/alarm in the SINAMICS V-ASSISTANT engineering tool.

Fault list

Fault	Description	Fault	Description
F1000	Internal software error	F7491	STOP cam minus reached
F1001	Floating Point exception	F7492	STOP cam plus reached
F1002	Internal software error	F7493	LR: Overflow of the value range for position actual value
F1003	Acknowledgment delay when accessing the memory	F7575	Drive: Motor encoder not ready
F1015	Internal software error	F7599	Encoder 1: Adjustment not possible
F1018	Booting has been interrupted several times	F7800	Drive: No power unit present
F1030	Sign-of-life failure for master control	F7801	Motor overcurrent
F1611	SI CU: Defect detected	F7802	Infeed or power unit not ready
F1910	Fieldbus: Setpoint timeout	F7815	Power unit has been changed
F1911	PROFIdrive: Clock cycle synchronous operation clock cycle failure	F7900	Motor blocked/speed controller at its limit
F1912	PROFIdrive: Clock cycle synchronous operation sign-of-life failure	F7901	Motor overspeed

Fault	Description	Fault	Description
F7011	Motor overtemperature	F7995	Motor identification failure
F7085	Open-loop/closed-loop control parameters changed	F8501	PROFIdrive: Setpoint timeout
F7090	Drive: Upper torque limit less than the lower torque limit	F30001	Power unit: Overcurrent
F7093	Test signal error	F30002	DC link voltage, overvoltage
F7220	Drive: Master control by the PLC missing	F30003	DC link voltage, undervoltage
F7403	Lower DC link voltage threshold reached	F30004	Drive heat sink overtemperature
F7404	Upper DC link voltage threshold reached	F30005	Power unit: Overload I ² t
F7410	Current controller output limited	F30011	Line phase failure in main circuit
F7412	Commutation angle incorrect (motor model)	F30015	Phase failure motor cable
F7442	LR: Multiturn does not match the modulo range	F30021	Ground fault
F7443	Reference point coordinate not in the permission range	F30027	Precharging DC link time monitoring
F7447	Load gear: Position tracking, maximum actual value exceeded	F30036	Internal overtemperature
F7449	Load gear: Position tracking actual position outside the tolerance window	F30050	24 V supply overvoltage
F7450	Standstill monitoring has responded	F31100	Zero mark distance error
F7451	Position monitoring has responded	F31101	Zero mark failed
F7452	Following error too high	F31110	Serial communications error
F7453	Position actual value preprocessing error	F31111	Encoder 1: Absolute encoder internal error
F7458	EPOS: Reference cam not found	F31112	Error bit set in the serial protocol
F7459	Zero mark not detected	F31117	Inversion error signals A/B/R
F7460	EPOS: End of reference cam not found	F31130	Zero mark and position error from the coarse synchronization
F7464	EPOS: Traversing block is inconsistent	F31131	Encoder 1: Deviation position incremental/absolute too large
F7475	EPOS: Target position < start of traversing range	F31150	Initialization error
F7476	EPOS: Target position > end of the traversing range	F52904	Control mode change
F7481	EPOS: Axis position < software limit switch minus	F52980	Absolute encoder motor changed
F7482	EPOS: Axis position > software limit switch plus	F52981	Absolute encoder motor mismatched
F7484	EPOS: Fixed stop outside the monitoring window	F52983	No encoder detected
F7485	EPOS: Fixed stop not reached	F52984	Incremental encoder motor not configured
F7488	EPOS: Relative positioning not possible	F52985	Absolute encoder motor wrong
F7490	Enable signal withdrawn while traversing	F52987	Absolute encoder replaced

Alarm list

Alarm	Description	Alarm	Description
A1009	Control module overtemperature	A7473	EPOS: Beginning of traversing range reached
A1019	Writing to the removable data medium unsuccessful	A7474	EPOS: End of traversing range reached
A1032	All parameters must be saved	A7477	EPOS: Target position < software limit switch minus
A1045	Configuring data invalid	A7478	EPOS: Target position > software limit switch plus
A1902	PROFIdrive: Clock cycle synchronous operation parameterization not permissible	A7479	EPOS: Software limit switch minus reached
A1920	Drive Bus: Receive setpoints after To	A7480	EPOS: Software limit switch plus reached
A1932	Drive Bus clock cycle synchronization missing for DSC	A7483	EPOS: Travel to fixed stop clamping torque not reached
A1940	PROFIdrive: Clock cycle synchronism not reached	A7486	EPOS: Intermediate stop missing
A1944	PROFIdrive: Sign-of-life synchronism not reached	A7487	EPOS: Reject traversing task missing
A5000	Drive heat sink overtemperature	A7496	EPOS: Enable not possible
A6310	Supply voltage (p29006) incorrectly parameterized	A7530	Drive: Drive Data Set DDS not present
A7012	Motor temperature model 1/3 overtemperature	A7565	Drive: Encoder error in PROFIdrive encoder interface 1
A7092	Drive: Moment of inertia estimator still not ready	A7576	Encoderless operation due to a fault active
A7440	EPOS: Jerk time is limited	A7582	Position actual value preprocessing error
A7441	LR: Save the position offset of the absolute encoder adjustment	A7805	Power unit overload I ² t
A7454	LR: Position value preprocessing does not have a valid encoder	A7965	Save required
A7455	EPOS: Maximum velocity limited	A7971	Angular commutation offset determination activated
A7456	EPOS: Setpoint velocity limited	A7991	Motor data identification activated
A7457	EPOS: Combination of input signals illegal	A8511	PROFIdrive: Receive configuration data invalid
A7461	EPOS: Reference point not set	A8565	PROFIdrive: Consistency error affecting adjustable parameters
A7462	EPOS: Selected traversing block number does not exist	A30016	Load supply switched off
A7463	EPOS: External block change not requested in the traversing block	A30031	Hardware current limiting in phase U
A7467	EPOS: Traversing block has illegal task parameters	A31411	Absolute encoder signals internal alarms
A7468	EPOS: Traversing block jump destination does not exist	A31412	Error bit set in the serial protocol
A7469	EPOS: Traversing block < target position < software limit switch minus	A52900	Failure during data copying
A7470	EPOS: Traversing block > target position > software limit switch plus	A52901	Braking resistor reaches alarm threshold
A7471	EPOS: Traversing block target position outside the modulo range	A52902	Emergency missing
A7472	EPOS: Traversing block ABS_POS/ABS_NEG not possible		

Siemens AG
Division Digital Factory
Postfach 48 48
90026 NÜRNBERG
GERMANY

Getting Started
A5E37208904-004, 04/2018